

ViewSonic®



CDE3201LED

LCD Display

User Guide

IMPORTANT: Please read this User Guide to obtain important information on installing and using your product in a safe manner, as well as registering your product for future service. Warranty information contained in this User Guide will describe your limited coverage from ViewSonic Corporation, which is also found on our web site at <http://www.viewsonic.com> in English, or in specific languages using the Regional selection box in the upper right corner of our website. “Antes de operar su equipo lea cuidadosamente las instrucciones en este manual”

Model No. VS15045

Contents

Compliance Information	i
Declaration of RoHS Compliance	ii
Copyright Information	iii
Product Registration	iii
Important Safety Instructions	iv
Getting Started	1
Package Contents	1
Installing the LCD Display	2
Installing the Stand	2
Disconnecting the Stand	2
Mounting ViewSonic LCD display to the wall	3
Wall Mount Kit Specifications (VESA)	4
Front View of the Product	5
Rear View of the Product	6
Connecting the LCD Display	7
HD Cable Box/HD Satellite Box	7
Personal Computer	9
Using the LCD Display Features	11
Remote Control and LCD Display Controls	11
Inserting Remote Control Batteries	11
Remote Control and LCD Display Controls	11
Operation	13
Other Information	26
Troubleshooting	26
Specifications	28
RS232 Protocol	29
Customer Support	37
Limited Warranty	38
Mexico Limited Warranty	39

Compliance Information

FCC Statement

This device complies with part 15 of FCC Rules. Operation is subject to the following two conditions: (1) this device may not cause harmful interference, and (2) this device must accept any interference received, including interference that may cause undesired operation.

This equipment has been tested and found to comply with the limits for a Class B digital device, pursuant to part 15 of the FCC Rules. These limits are designed to provide reasonable protection against harmful interference in a residential installation. This equipment generates, uses, and can radiate radio frequency energy, and if not installed and used in accordance with the instructions, may cause harmful interference to radio communications. However, there is no guarantee that interference will not occur in a particular installation. If this equipment does cause harmful interference to radio or television reception, which can be determined by turning the equipment off and on, the user is encouraged to try to correct the interference by one or more of the following measures:

- Reorient or relocate the receiving antenna.
- Increase the separation between the equipment and receiver.
- Connect the equipment into an outlet on a circuit different from that to which the receiver is connected.
- Consult the dealer or an experienced radio/TV technician for help.

Warning: You are cautioned that changes or modifications not expressly approved by the party responsible for compliance could void your authority to operate the equipment.

Following information is only for EU-member states:

The mark shown to the right is in compliance with the Waste Electrical and Electronic Equipment Directive 2002/96/EC (WEEE).

The mark indicates the requirement NOT to dispose the equipment as unsorted municipal waste, but use the return and collection systems according to local law.

If the batteries, accumulators and button cells included with this equipment, display the chemical symbol Hg, Cd, or Pb, then it means that the battery has a heavy metal content of more than 0.0005% Mercury or more than, 0.002% Cadmium, or more than 0.004% Lead.



ENERGY STAR Information:

Keeping the LCD display at its factory default settings that meet ENERGY STAR criteria.

Enabling certain features and functionality of LCD display will increase its energy consumption, possibly beyond the limits required for ENERGY STAR qualification.

SRS Trademark Information:



- **TruSurround HD** is a trademark of SRS Labs, Inc. TruSurround HD technology is incorporated under license from SRS Labs, Inc.

SRS TruSurround HD™ creates an immersive, feature-rich surround sound experience from two speakers, complete with rich bass, high frequency detail and clear dialog.

Declaration of RoHS Compliance

This product has been designed and manufactured in compliance with Directive 2002/95/EC of the European Parliament and the Council on restriction of the use of certain hazardous substances in electrical and electronic equipment (RoHS Directive) and is deemed to comply with the maximum concentration values issued by the European Technical Adaptation Committee (TAC) as shown below:

Substance	Proposed Maximum Concentration	Actual Concentration
Lead (Pb)	0.1%	< 0.1%
Mercury (Hg)	0.1%	< 0.1%
Cadmium (Cd)	0.01%	< 0.01%
Hexavalent Chromium (Cr ⁶⁺)	0.1%	< 0.1%
Polybrominated biphenyls (PBB)	0.1%	< 0.1%
Polybrominated diphenyl ethers (PBDE)	0.1%	< 0.1%

Certain components of products as stated above are exempted under the Annex of the RoHS Directives as noted below:

Examples of exempted components are:

1. Mercury in compact fluorescent lamps not exceeding 5 mg per lamp and in other lamps not specifically mentioned in the Annex of RoHS Directive.
2. Lead in glass of cathode ray tubes, electronic components, fluorescent tubes, and electronic ceramic parts (e.g. piezoelectronic devices).
3. Lead in high temperature type solders (i.e. lead-based alloys containing 85% by weight or more lead).
4. Lead as an allotting element in steel containing up to 0.35% lead by weight, aluminium containing up to 0.4% lead by weight and as a copper alloy containing up to 4% lead by weight.

Copyright Information

Copyright © ViewSonic® Corporation, 2012. All rights reserved.

ViewSonic, the three birds logo, OnView, ViewMatch, and ViewMeter are registered trademarks of ViewSonic Corporation.

ENERGY STAR® is a registered trademark of the U.S. Environmental Protection Agency (EPA).

As an ENERGY STAR® partner, ViewSonic Corporation has determined that this product meets the ENERGY STAR® guidelines for energy efficiency.

Disclaimer: ViewSonic Corporation shall not be liable for technical or editorial errors or omissions contained herein; nor for incidental or consequential damages resulting from furnishing this material, or the performance or use of this product.

In the interest of continuing product improvement, ViewSonic Corporation reserves the right to change product specifications without notice. Information in this document may change without notice.

No part of this document may be copied, reproduced, or transmitted by any means, for any purpose without prior written permission from ViewSonic Corporation.

Product Registration

To meet your future needs, and to receive any additional product information as it becomes available, please register your product on the Internet at: www.viewsonic.com.

For Your Records	
Product Name:	CDE3201LED ViewSonic LCD Display
Model Number:	VS15045
Document Number:	CDE3201LED_UG_ENG Rev. 1A 09-05-12
Serial Number:	_____
Purchase Date:	_____

Product disposal at end of product life

ViewSonic respects the environment and is committed to working and living green. Thank you for being part of Smarter, Greener Computing. Please visit ViewSonic website to learn more.

USA & Canada: <http://www.viewsonic.com/company/green/recycle-program/>

Europe: <http://www.viewsoniceurope.com/uk/support/recycling-information/>

Taiwan: <http://recycle.epa.gov.tw/recycle/index2.aspx>

Important Safety Instructions

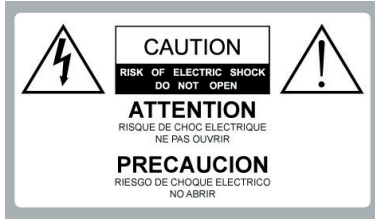

Dangerous Voltage: The lightning flash with arrowhead symbol, within an equilateral triangle, is intended to alert the user to the presence of dangerous voltage within the inside of the product that may be sufficient level to constitute a risk of electric shock to persons.



Instruction: The exclamation point within an equilateral triangle is intended to alert the user to the presence of important operating and servicing instructions in the literature accompanying the appliance.

1. Read these instructions completely before using the equipment.
2. Keep these instructions in a safe place.
3. Heed all warnings.
4. Follow all instructions.
5. Do not use this apparatus near water.
6. Clean with a soft, dry cloth.
7. Do not block any ventilation openings. Install the equipment in accordance with the manufacturer's instructions.
8. Do not install near any heat sources such as radiators, heat registers, stoves, or other devices (including amplifiers) that produce heat.

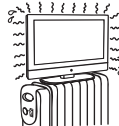

9. Do not attempt to circumvent the safety provisions of the polarized or grounding-type plug. A polarized plug has two blades with one wider than the other. A grounding type plug has two blades and a third grounding prong. The wide blade and the third prong are provided for your safety. If the provided plug does not fit into your outlet, consult an electrician for replacement of the outlet.
10. Prevent the power cord from being tread upon or pinched, particularly at the plug, convenience receptacles, and the point where they exit from the device. Be sure that the power outlet is located near the equipment so that it is easily accessible.
11. Only use attachments/ accessories specified by the manufacturer.
12. Use only with the cart, stand, tripod, bracket, or table specified by the manufacturer, or sold with the apparatus. When a cart is used, use caution when moving the cart/ apparatus combination to avoid injury from tip-over.
13. Unplug this apparatus when it will be unused for a long period of time.
14. Refer all servicing to qualified service personnel. Servicing is required when the apparatus has been damaged in any way, such as power-supply cord or plug is damaged, liquid has been spilled or objects have fallen into the apparatus, the apparatus



has been exposed to rain or moisture, or the unit does not operate normally, or has been dropped.

USE

AC power Cord

Keep the following guidelines to protect the AC power cord from being damaged. If the AC power cord is damaged, it may result in a fire or an electric shock. Stop using it and ask your dealer or ViewSonic service center to exchange it.

- Do not place the LCD display where the power cord is subject to wear or abuse.
- Do not pinch, bend, or twist the cord excessively.
- The core lines may be bared and cut, causing a short-circuit, and resulting in a fire or an electric shock.
- Do not convert or damage the power cord.
- Avoid power cord being rolled over or rested upon.
- When the power cord is plugged in, do not move the LCD display.
- Keep the power cord away from heat sources.
- When you disconnect the AC power cord, disconnect it from the wall outlet first.
- When disconnecting the power cord, grasp the plug instead of pulling the power cord.
- Use only an original ViewSonic AC power cord, not other brands.
- Do not use the supplied AC power cord on any other equipment.



Wall outlet

Insert the plug fully into the outlet. If it is loose, do not use it. Doing so may cause arcing and result in a fire. Contact your electrician to change the outlet.



Wiring

For your safety, be sure to unplug the AC power cord when connecting cables.

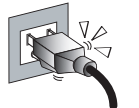

Take care not to trip on the cables. It may cause damage to the LCD display set.

Electric shock

Do not touch the AC power cord or the LCD display with a wet hand. If you plug/unplug the AC power cord from the LCD display with a wet hand, it may cause electric shock.



Lightning storms

During a lightning storm, unplug the LCD display from the wall outlet and disconnect the antenna to prevent damage to the LCD display.

When not in use

If you will not be using the LCD display set for long periods of time, the LCD display set should be disconnected from the AC power outlet to prevent power line surges. The LCD display set is not disconnected from the AC power source when the LCD display set is switched off.

To disconnect the LCD display set completely, unplug from the AC power outlet.

Overloading

This LCD display set is designed to operate on a 120V AC supply only. If there are too many appliances connected to the same AC power outlet, it could result in a fire or an electric shock.

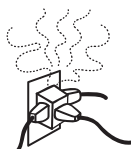

Optional equipment

If optional equipment is to be installed, leave some space between optional equipment and the LCD display set. Picture distortion and/or noisy sound may occur if the LCD display set is positioned in close proximity to any equipment emitting electromagnetic radiation.

Small accessories

Keep small accessories in a safe place where children are unable to reach.

Magnetic influence

This LCD display contains a strong magnet in the speaker unit that generates a magnetic field. Keep any items susceptible to magnetic fields away from the speaker.

Sound

If you hear snapping or popping sound comes from the LCD display continuously or frequently while the LCD display is operating, unplug the LCD display and consult your dealer or service technician. It is normal for some LCD displays to make occasional snapping or popping sounds, particularly when being turned on or off.



Use in outdoor

This LCD display is not designed for outdoors installation. Do not expose the LCD display to rain, as it may result in a fire or an electric shock. Also, do not expose the LCD display to direct sunlight, as it may heat up and become damaged.

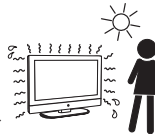

Vehicle, ships and other vessels

Do not install this LCD display in a vehicle.

Car accidents may cause the LCD display to fall down and cause injury.

Do not install this LCD display in a ship or vessel.

If the LCD display is exposed to seawater, it may cause a fire or damage the LCD display.



Medical institutions

Do not place this LCD display in a place where medical equipment is in use. It may cause the medical equipment to malfunction.

Volume adjustment

- Adjust the volume to avoid disturbing your neighbors. Sound carries easily at night. Therefore, we suggest you close the windows or use headphones.
- When using headphones, adjust the volume to appropriate levels, or hearing damage may result.

ANTENNAS

Outdoor antenna grounding

If an outdoor antenna is installed, follow the precautions below.

Do not install the outdoor antenna system near of overhead power lines or other electric light or power circuits, or where it can come in contact with such power lines or circuits.

WHEN INSTALLING AN OUTDOOR ANTENNA SYSTEM, EXTREME CARE SHOULD BE TAKEN TO KEEP FROM CONTACTING SUCH POWER LINES OR CIRCUITS AS CONTACT WITH THEM IS ALMOST INVARIABLY FATAL.

Be sure the antenna system is grounded so that it can provide some

protection against voltage surges and built-up static charges.

Section 810 of the National Electrical Code (NEC) in the U.S.A. and Section 54 of the Canadian Electrical Code in Canada provides information with in regard to proper grounding of the mast and supporting structure, grounding of the lead-in wire to an antenna discharge unit, size of grounding conductors, location of antenna discharge unit, connection to grounding electrodes, and requirements for the grounding electrode.

Antenna grounding according to the National Electrical Code, ANS/NFPA 70

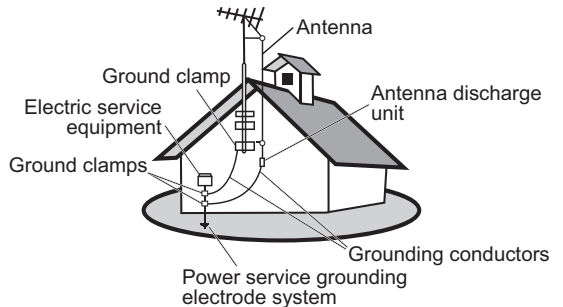

CLEANING

Cleaning the AC power plug

Unplug the AC power plug and clean it regularly. If the plug is covered with dust and gathers moisture, its insulation may deteriorate and result in a fire.

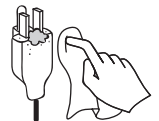

Cleaning the screen surface/ cabinet of the LCD display set

When cleaning this LCD display, unplug the AC power cord. If not, it may result in electric shock. Use a dry soft cloth to clean the cabinet of the LCD display. To remove dust near the screen, wipe it gently with a soft cloth. Stubborn stains may be removed with a cloth slightly dampened with a solution of mild soap and warm water. Never use strong solvents such as thinner or benzene for cleaning. If using a chemically pretreated cloth, please follow the instruction provided on the package. The ventilation holes can accumulate dust over time.



To ensure proper ventilation, we recommend you to remove the dust periodically (once a month) using a vacuum cleaner, while the LCD display is powered off.

Disclaimer

Some chemical cleaners have been reported to damage the screen and/or case of the LCD display. ViewSonic will not be liable for damage resulting from use of these cleaners.

CARRYING THE LCD DISPLAY

Carry the LCD display as instructed

To prevent dropping the LCD display and causing serious injury, you must follow these guidelines:

- Disconnect all cables before carrying the LCD display.
- Carrying the large size LCD display requires at least two or three people.
- When you carry the LCD display, place your hands as illustrated and hold it securely. Do not put stress on the LCD panel and the frame around the screen.
- When carrying the LCD display, do not subject it to shocks, vibration, or excessive force.

- When lifting or moving the LCD display, hold it securely from the bottom. Place your palm directly under the panel.

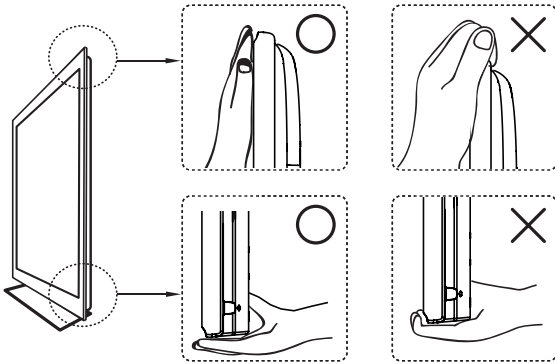

VENTILATION

Slots and openings in LCD display are provided for ventilation.

To ensure reliable operation of the LCD display and to protect it from overheating, be sure these openings are not blocked or covered.

The LCD display may accumulate dust and get dirty if proper ventilation is not provided. For proper ventilation, follow the following guidelines:

- Never install the LCD display face up, down or sideways.
- Never install the LCD display turned over or upside down.
- Never cover the slots and openings with a cloth or other materials.
- Never block the slots and openings by placing the LCD display on a bed, sofa, rug or other similar surface.
- Never place the LCD display in a confined space, such as a bookcase or built-in cabinet, unless proper ventilation is provided.



Leave some space around the LCD display set as shown below. Otherwise, air-circulation may be inadequate and cause overheating, which may cause a fire or damage to the LCD display set.

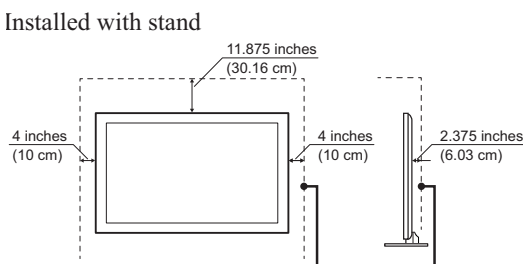
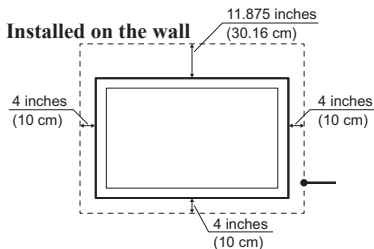

Leave at least this space around the set.

Do not install the LCD display set as follows:

Air circulation is blocked.

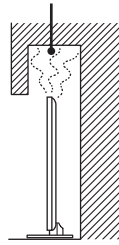

Air circulation is blocked.

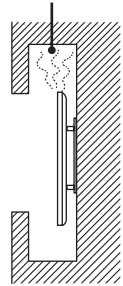

Objects and ventilation holes

Never push any objects into the slots on the LCD display cabinet as they may touch dangerous voltage points or short out parts that could result in a fire or an electric shock. Do not place any objects on the LCD display.

MOISTURE

Moisture and flammable objects

- Keep the product away from moisture. Do not expose this appliance to rain or moisture. Do not place objects filled with liquids, such as vases, on the LCD display.
- Do not use power-line operated LCD display sets near water, such as in places like a bathtub, washbowl, kitchen sink, laundry tub, a wet basement, or near a swimming pool, etc. It may cause fire or electric shock.
- Do not let this LCD display get wet. Never spill liquid of any kind on the LCD display. If water penetrates into the product, unplug the power cord and contact ViewSonic.
- Do not operate the LCD display when wet. It may result in electric shock or damage to the LCD display.
- To prevent fire, keep flammable objects or open flame (e.g. candles) away from the LCD display.

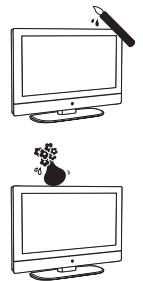

INSTALLATION

Optional wall mount

To do Wall mount installation, you need a Wall-Mount Bracket. When installing or removing the LCD display using the Wall-Mount Bracket, be sure to use qualified contractors. If not properly secured during installation or removal from the Wall-Mount Bracket, the LCD display may fall and cause serious injury.

- When installing the LCD display using a Wall-Mount Bracket, make sure you follow the operating instructions supplied with the Wall-Mount Bracket.
- Attach the brackets supplied with the Wall-Mount Bracket.
- The LCD display is not designed for hanging from the ceiling. It may fall and cause serious injury.

Placement

The LCD display should be installed near an easily accessible AC power outlet.

Observe the following to prevent the LCD display from falling from the stand or wall mount.

- Place the LCD display on a stable, level surface.
- Do not hang anything on the LCD display. Do not allow children to climb on the LCD display. Do not install the LCD display in places subject to



extreme temperature, such as in direct sunlight, near a radiator, or heating vent. If the LCD display is exposed to extreme temperature, the LCD display may overheat and cause deformation of the enclosure or cause malfunction.

- Do not install the LCD display in a place exposed to direct air conditioning.
- If the LCD display is installed in such a location, moisture may condense inside and may cause a malfunction.
- Do not place the LCD display in hot, oily, humid or excessively dusty places.
- Do not install the LCD display where insects may enter.
- Do not install the LCD display where it may be exposed to mechanical vibration.
- Do not install the LCD display in a location where it may spear up, such as on or behind a pillar, or where you might bump your head on it. It may cause injury.



Preventing the LCD display from toppling over

To prevent the LCD display from toppling over, secure the LCD display to a wall or stand.

Placement for watching

We suggest you to watch the LCD display at a distance of 3-7 times that of the screen height, and not in excessive brightness. It is easy to cause eye fatigue if you watch LCD display for too long or in a dark room. To obtain clear picture, do not expose the screen to direct illumination or sunlight. Use spot lighting directed down from the ceiling if you can.

LCD SCREEN

- Although the LCD screen is made with high precision technology and has effective pixels of 99.99% or more, black dots or bright points or light (red, blue, or green) may appear constantly on the LCD screen. This is a structural property of the LCD panel and is not a malfunction.
- The LCD screen is made with high-precision technology. To achieve a high level of performance and picture quality, this LCD display's backlight setting is set to maximize the brightness of the LCD display. However, uneven brightness may be observed when the LCD display is viewed in a dark environment without an input source or a blank screen. This is a normal condition, not a malfunction of the LCD display. To improve this condition, change the Picture mode, Backlight setting, enable the Light Sensor, or turn on the Power management.
- Avoid exposing the LCD screen surface to direct sunlight. It is likely to damage the LCD panel.
- Do not push or scratch the LCD screen, or place objects on top of the LCD display. The image may be uneven or the LCD panel may be damaged.
- If the LCD display is used in a cold place, a smear may occur in the picture or the picture may become dark. It is not caused by a failure. This condition will improve as the temperature rises.
- When still pictures are displayed continuously, ghosting may occur. It should disappear after a short period of time.
- The screen and cabinet get warm when the LCD display is in use. This is a normal condition.
- Spraying insect repellent with volatile material on the screen will cause damage.
- Do not make prolonged contact with rubber or plastic material.

Broken pieces

Do not throw anything at the LCD display. Doing so may break the screen glass and cause serious injury.

If the surface of the LCD display cracks, unplug the AC power cord before touching the LCD display. Otherwise electric shock may result.



Handling of broken glass and liquid crystal leakage

If the LCD panel gets damaged, crystalline liquid leakage may occur, or scattered broken glass may result. Do not touch broken glass or crystalline liquid which is toxic, with bare hands as cuts, poisoning or skin irritation may occur. Also do not glass fragments or leaked crystalline liquid get into your eyes or mouth. Should either contacted your eyes or mouth, rinse the contacted area thoroughly with water and consult your doctor.

SERVICING

Do not attempt to repair the LCD display yourself, since opening the cabinet may expose you to dangerous voltage or other hazards. Ask qualified service personnel to do the servicing for your LCD display.



Replacement parts

When replacement parts are required, be sure the service technician certifies in writing that he/she has used replacement parts specified by the manufacturer that have the same characteristics as the original parts. Unauthorized substitutions may cause a fire, an electric shock or other hazards.

Safety check

Upon completion of repairs to the LCD display, ask the service technician to perform routine safety checks (as specified by the manufacturer) to determine that the LCD display is safe for operating, and to so certify.

Ask a qualified service technician to dispose of the LCD display.

Getting Started

Package Contents

Please make sure the following items are included with your LCD display. If any items are missing, please contact your dealer.



LCD display



Remote Control with batteries

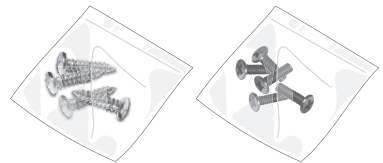

Stand screws



ViewSonic User Guide

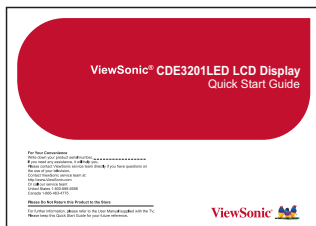

ViewSonic Quick Start Guide

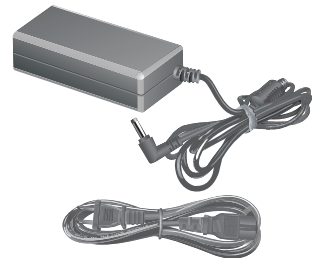

Power adapter

Getting Started

Installing the LCD Display

Installing the Stand

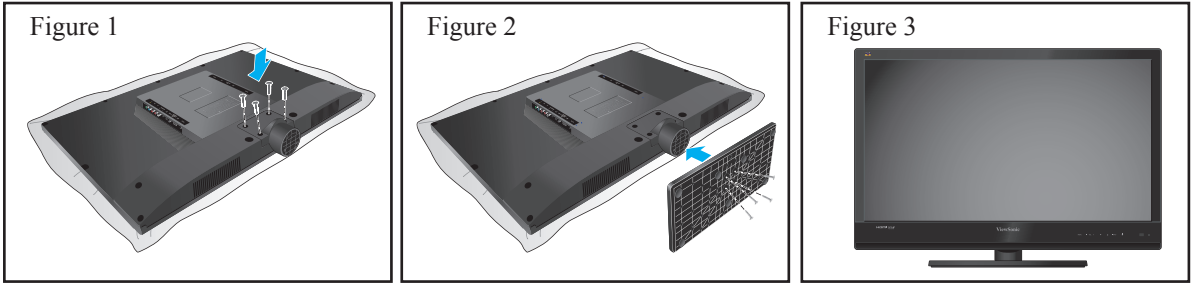

1. Carefully place the LCD display screen side down on a cushioned surface to protect the screen from damage.
(see Figure 1)
2. Attach the foot stand and secure it with the included screws. Please fasten with a cross screw driver.
(see Figure 2)
3. Stand the LCD display up. (see Figure 3)

Disconnecting the Stand

1. Carefully place the LCD display screen side down on a cushioned surface to protect the screen from damage. (see Figure 1)
2. Remove the screws and detach the stand from the LCD display. (see Figure 2)

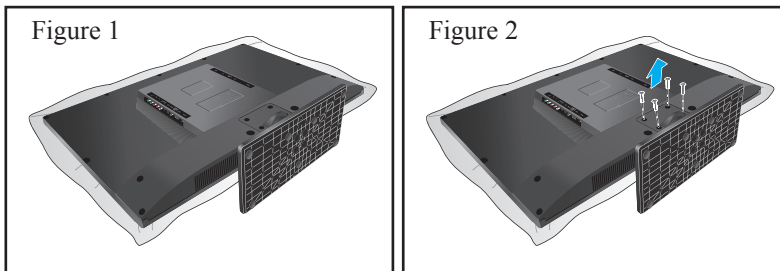

Getting Started

Mounting ViewSonic LCD display to the wall

The LCD display can be used in a free standing position or wall-mounted. Before installing the product to the wall, please consider the following guidelines:

- Read the Important Safety Instructions, at the start of this manual.
- Do not install in a moist or wet environment. This equipment is intended for indoor use.
- Do not install near heat source, or strong magnetic fields.
- Use only ViewSonic approved wall-mounting brackets to support the LCD display weight.
- Before attaching the wall mount plate to the back cover, ensure the product is working.
- If your LCD display is already set up for free-standing operation, you need to first remove the stand before mounting the device to the wall.

To attach the wall-mount bracket to LCD display safely, please use the following guidelines:

- Disconnect the power and any other cables that might hinder moving the LCD display.
- Set the LCD display on a table or work surface, placing the screen face down on a towel or woolen blanket to protect the screen surface from damage while installing plate.
- Before installing the LCD display on the wall, ensure you have recorded the product serial number on page (i) of the User Guide, as you will need the serial number to request service should there be a service need.
- Install the wall mount plate to the LCD display using screws NO LONGER than 12mm, as longer screws found in universal (non-ViewSonic) wall mount kits may damage the power supply causing the unit to fail. The wall-mount screw type is M6 x L12.

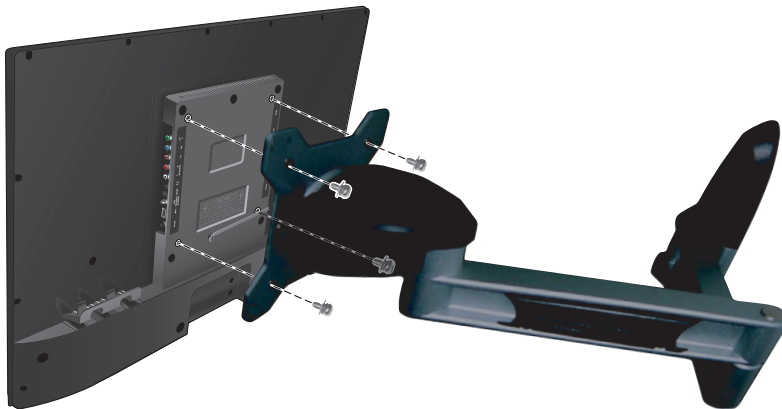

- Mount the wall mount bracket to the wall ensuring use of proper screws to support the installation. Ensure there is at least 3cm of space surrounding any air-vents of your LCD display to allow adequate cooling during operation.
- Hang the LCD display wall mount plate to the wall mount bracket, completing installation. Enjoy your ViewSonic LCD display!

Getting Started

Wall Mount Kit Specifications (VESA)

When attaching to other building materials, please contact your nearest dealer.

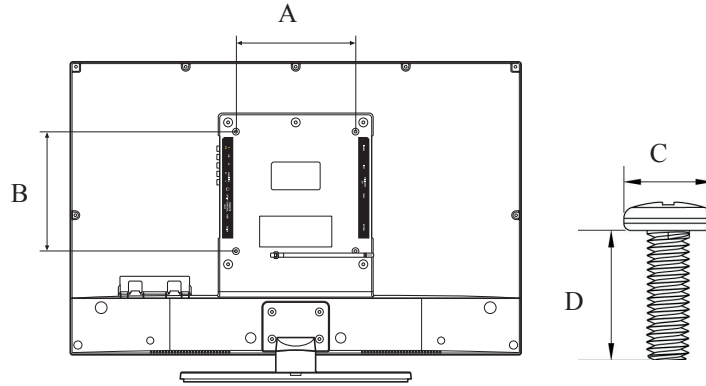

Product Family	inch	VESA Spec. (A x B)	Standard Screw (C x D)	Quantity
LCD display	32	200 x 200 mm	M6 x L12	4

- ViewSonic provides the standard dimensions for wall mount kits as shown in the table above.
- To find the perfect mount, please browse www.viewsonic.com or call our service team: United States 1-800-688-6688, Canada 1-866-463-4775.
- When purchasing our wall mount kit, a detailed install manual and all parts necessary for assembly are provided.
- Do not use the screws that longer than the standard dimension, as they may cause damage to the inside of the LCD display set.

Front View of the Product

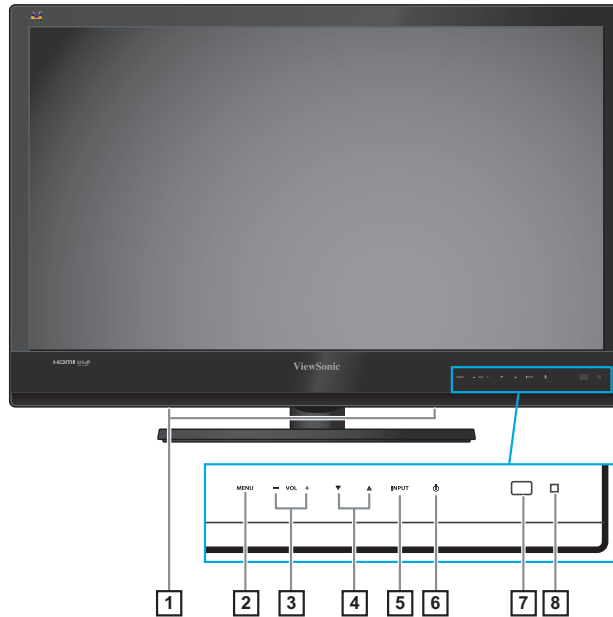

Item	Icon	Description
1 Speakers		Emit audio sound.
2 Menu	MENU	Turn the on-screen display (OSD) menu on / off.
3 Volume	VOL -	Decrease the volume. Move to the left or adjust the setting on the OSD menu.
	VOL +	Increase the volume. Move to the right or adjust the setting on the OSD menu.
4 OSD Item Select	▼	Move downward to scroll through menu options.
	▲	Move upward to scroll through menu options.
5 Input	INPUT	Select the input source. Enter the submenu.
6 Power	⏻	Turn the power on from standby mode. Touch it again to return to standby mode.
7 Remote Control Receiver		Receive IR signals from the remote control.
8 LED Indicator		Blue indicates power on. Red indicates standby mode.

Rear View of the Product



Item	Description
1 YPbPr signal input	Connect to the YPbPr output of A/V device. * Composite and Y use the same connector.
2 Audio input (left/ right)	Connect to the corresponding audio connectors on your A/V device.
3 Earphone Jack	Connect to earphones. By connecting the earphones, you can listen to the sound from the LCD display through the earphones. * If you connect the earphones, the LCD display speakers will be muted.
4 SPDIF Optical output	Connect to the SPDIF input of A/V device.
5 Remote Control output	Connect to an IR emitter. This will enable the remote control of external equipment.
6 USB	Connect to USB devices, such as USB flash drive.
7 DC input	Connect to the DC input power source.
8 HDMI input	Connect to the HDMI output of A/V devices.
9 DVI input	Connect to the DVI output of PC devices.
10 PC Audio input	Connect to a PC line / audio port.
11 VGA signal input	Connect to a PC VGA port.
12 RS232 signal input	Reserved for the service technician's use.

Getting Started

Connecting the LCD Display

HD Cable Box/HD Satellite Box

You can also enjoy high-definition programming by subscribing to a high-definition cable service or a high-definition satellite service. For the optimum picture quality, be sure to connect this device to your LCD display via the HDMI or component video (with audio) input on the rear side of your LCD display.

HDMI Connection

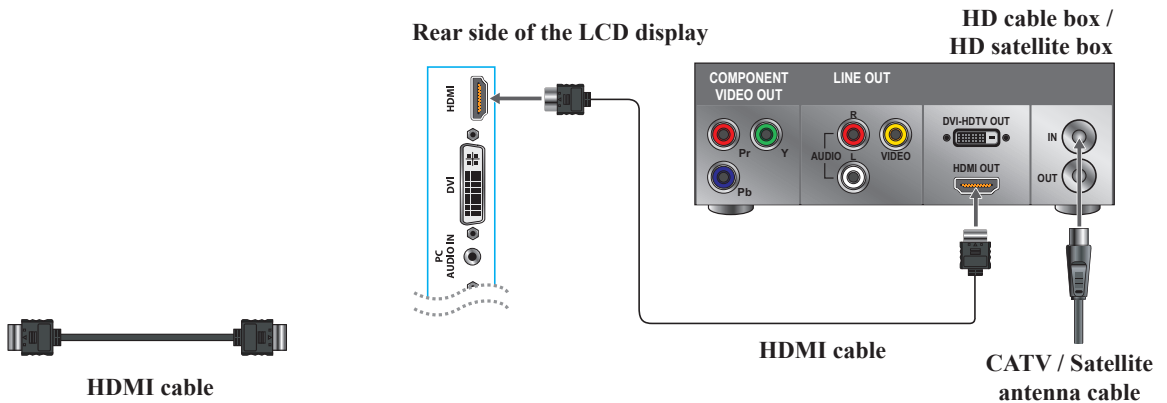

DVI Connection

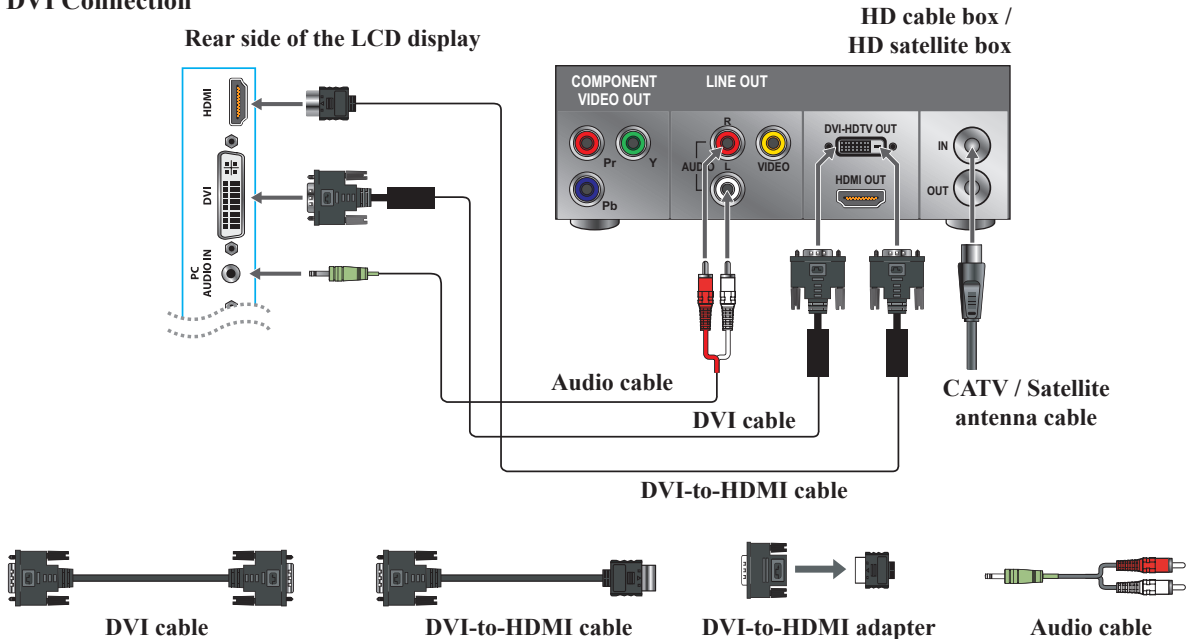

- For DVI connection, connect the HDMI jack (with DVI cable, DVI-to-HDMI cable, or DVI-to-HDMI adapter), and connect the audio jack to the AUDIO IN jacks of PC Audio input.

Getting Started

HDMI Timing Reference Chart

No.	Mode	HDMI	DVI
1	VGA60(640x480)	V	V
2	SVGA60(800x600)	V	V
3	XGA60(1024x768)	V	V
4	SXGA60(1280x1024)	V	V
5	WXGA60(1360x768)	V	V
6	1280 x 800	V	V
7	1440 x 900	V	NA
8	1680 x 1050	V	NA
9	1920 x 1080	V	NA
10	480i60	V	NA
11	576i50	V	NA
12	480P60	V	V
13	576P50	V	V
14	720P50	V	V
15	720P60	V	V
16	1080I50	V	NA
17	1080I60	V	NA
18	1080P50	V	NA
19	1080P60	V	NA
20	1080P24	V	NA

YPbPr or Component Connection

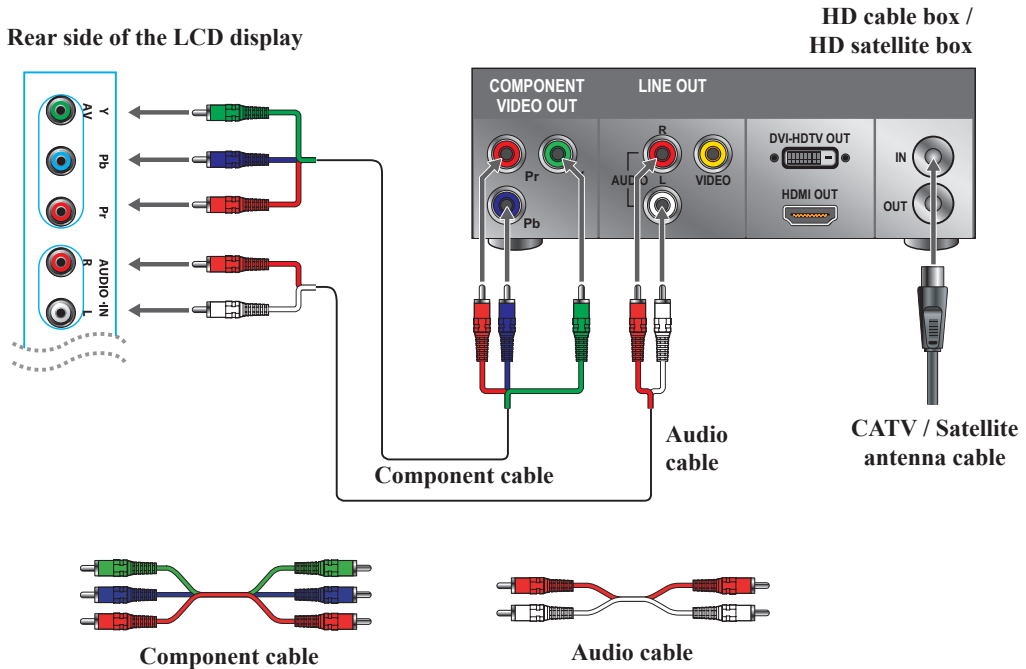

☀
 • YPbPr provides better quality than the AV connection.

Getting Started

AV Connection

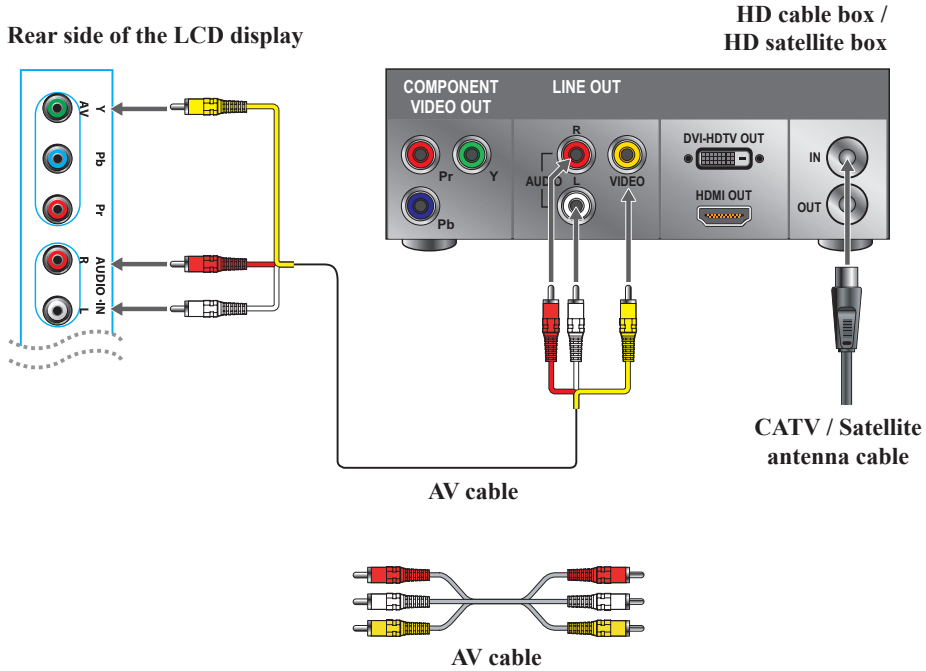

Programming your Cable or Satellite Box remote

Refer to the user manual from your service provider to determine the setting.

If it requires:

- 3 digits, please try “566”, “565”, “556”, or “688”. It usually works with DISHNetwork.
- 4 digits, please try “0054”. It usually works with Cox.
- 5-digits, please try “11454”, “11054”, or “10690”. It usually works with DIRECTV.

Personal Computer

Use the LCD display as the monitor of your computer.

Rear side of the LCD display

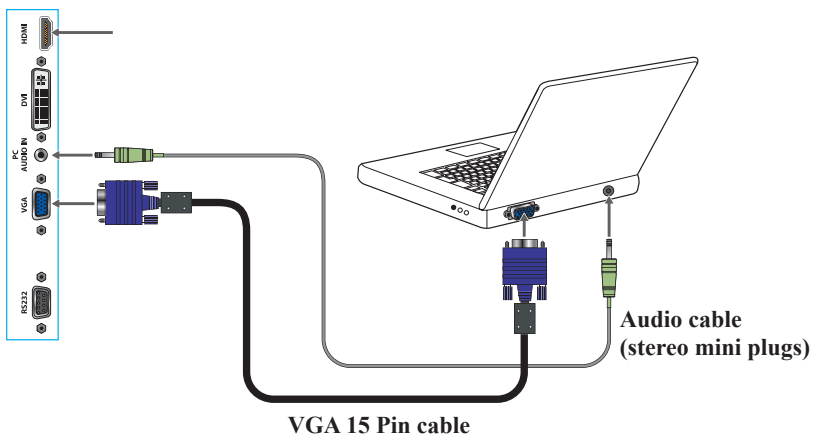

- Connect the PC IN jack to the PC using a 15-pin cable and audio cable.

Getting Started

PC Timing Reference Chart

<i>No</i>	<i>VGA Timing</i>		<i>Panel FullHD (1920 x 1080) Support</i>				<i>Support</i>
	<i>Mode</i>	<i>Resolution</i>	<i>H sync (kHz)</i>	<i>V sync (Hz)</i>	<i>Pixel clock (MHz)</i>	<i>Polarity</i>	
1	IBM VGA	720 x 400	31.47	70.09	28.32	N/P	V
2	VESA DMT	640 x 480	31.5	59.94	25.175	N/N	V
3	VESA DMT	800 x 600	37.88	60.32	40	P/P	V
4	VESA DMT	1024 x 768	48.36	60	65	N/N	V
5	VESA DMT	1280 x 768	47.77	59.8	79.5	N/P	V
6	VESA DMT	1280 x 800	49.7	59.81	83.5	N/P	V
7	VESA DMT	1280 x 1024	63.98	60.02	108	P/P	V
8	VESA DMT	1360 x 768	47.71	60.01	85.5	P/P	V
9	VESA DMT	1440 x 900	55.94	59.89	106.5	N/P	V
10	VESA DMT	1680 x 1050	65.29	59.95	146.25	N/P	V
11	CEA	1920 x 1080	67.5	60	148.5	P/P	V



- This VGA input does not support interlaced signals.

Using the LCD Display Features

Remote Control and LCD Display Controls

Inserting Remote Control Batteries

1. Remove the battery cover by pulling then lifting the knob on the cover.
2. Insert the batteries, corresponding to the (+) and (-) markings on the battery compartment.
3. Reattach the battery cover.

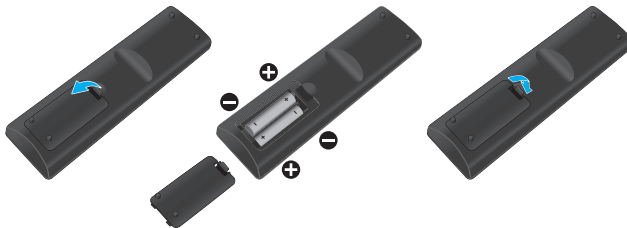

⚠ CAUTION

- Only use the specified AAA batteries.
- Do not mix new and old batteries. This may result in creaking or leakage, which may pose a risk of fire or lead to personal injury.
- Insert batteries according to (+) and (-) markings. Inserting the batteries incorrectly may result in leakage, which may pose a risk of fire or lead to personal injury.
- Dispose of the battery in accordance with local laws and regulations.
- Keep the batteries away from children or pets.
- When the remote control will not to be used for an extended period, remove the batteries.

Remote Control and LCD Display Controls

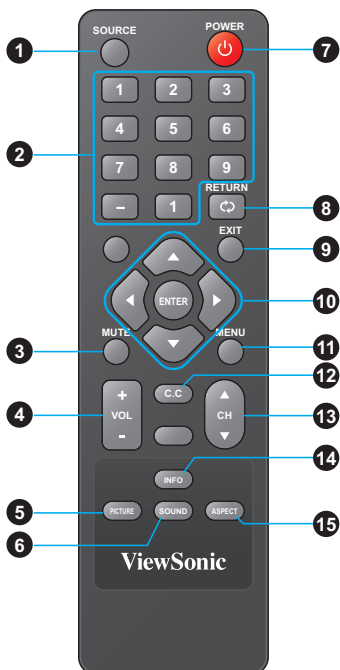

Touch keys located at the front side of the LCD display operate the same as these buttons on the remote control.



Button	Description
1 SOURCE	Press to display the Source Select list and select the source with ▲/▼. To confirm the selection, press ENTER.

Source Select

- AV
- YPbPr
- DVI
- HDMI
- PC
- USB

Using the LCD Display Features

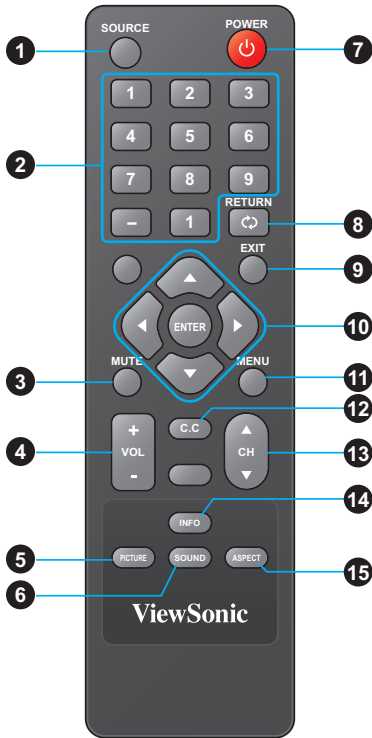

Button	Description
2 0~9, - number buttons	Press the respective button to input a character or number.
3 MUTE	Press to turn off the sound. To restore the sound, press this button again, or press the VOL+/- button.
4 - VOL +	Press to adjust the volume.
5 PICTURE	Press this button repeatedly to select the preset picture mode. Available options: Standard, Movie, User, Power Saving, or Dynamic.
6 SOUND	Press this button repeatedly to select the preset sound mode. Available options: Standard, Soft, User, User SRS, or Dynamic.
7 POWER	Press this button to turn the power on from standby mode. Press it again to return to standby mode.
8 RETURN	Press to return to the previous channel.
9 EXIT	Press to exit the OSD menu screen.
10 ▲▼◀▶/ ENTER buttons	Press these buttons to navigate the OSD menus. <ul style="list-style-type: none"> • ▲/▼ - move upward/downward to select menu options. • ◀/▶ - move to the right/left to select the main menu or adjust the settings. You can also use ▶ to enter the corresponding submenu. • ENTER: Confirm the selection or enter the corresponding submenu.
11 MENU	Press to turn the OSD (On-Screen Display) menu on.
12 C.C	Press to select the Closed Caption menu in the AV mode.
13 ▼ CH ▲	Press to change the channels up or down.
14 INFO	Press to display the current state of the LCD display.
15 ASPECT	Press this button repeatedly to select the screen size. Available options: Normal, Wide, Cinema, Zoom, or Full 100%. <i>* For Full 100% option, it is only available on HDMI/DVI input source.</i>

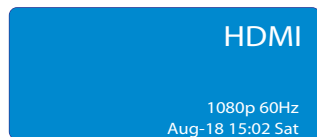

Using the LCD Display Features

Operation

Turning the LCD Display On and Off

Press  on the remote control.

You can also use the  key on the front side of the panel.

* If there is no input signal within 10 minutes, the LCD display will be turned off automatically.

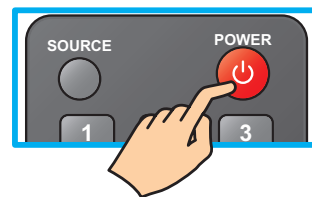

Adjusting the Volume

Press **VOL +/-** to adjust volume.

To turn off the volume, press **MUTE**.

To restore volume, press **MUTE** again, or press **VOL +/-** directly.

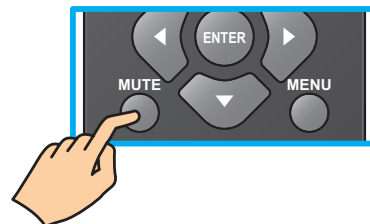

Viewing the Displayed Information

To display the current information of the LCD display:

Press **INFO**, and the current state will be displayed on the screen. (It shows all or some of the information about Input, Resolution, etc., depending on the input source)

* The illustration shows an example of the INFO screen in an HDMI source.

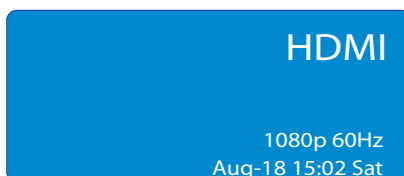

Using the LCD Display Features

Selecting the Input Source

To select the input sources connected to the LCD display:

1. Press **SOURCE** on the remote control.
2. Press **▲** or **▼** to select the desired input source.
3. To confirm the selection, press **ENTER**.



Using the Parent Controls

With PARENT CONTROL, you can block LCD display and movie programming based on Movie ratings. Password is required to access the PARENTAL CONTROL menu. The default is "0000".

To manage programs using the US Ratings system:

1. Press **MENU** to display the OSD main menu.
2. Press **◀** or **▶** to select **PARENTAL** menu, then press **ENTER** to enter the menu.
3. Enter the password.
4. Press **▲** or **▼** to select **V-CHIP**, then press **▶** to enter **V-CHIP** submenu.
5. Press **▲** or **▼** to select **US V-Chip**, then press **▶** to enter the US rating system submenu.

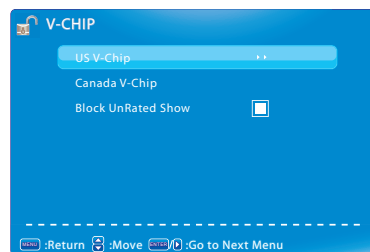
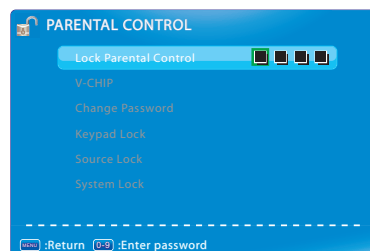

Movie Rating

1. Press **▲** or **▼** to select **Movie Rating**, then press **▶** to enter its submenu.

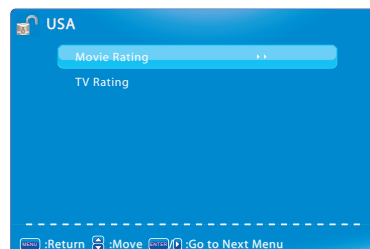

2. Press **▲** or **▼** to select your desired MPAA ratings level.

The MPAA ratings level are defined as following:

- G (general audience)
- PG (parental guidance suggested)
- PG-13 (recommended for children 14 years of age or older)

Using the LCD Display Features

- R (mature audience)
 - NC-17 (no one under 17 years of age)
 - X (adult audience only)
3. Press **ENTER** to lock (🔒) / unlock (🔓) your selection.
 4. Press **EXIT** to exit the menu.

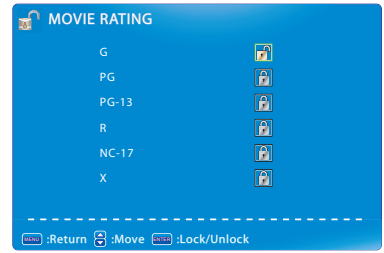

TV Rating

1. Press **▲** or **▼** to select **TV Rating**, then press **▶** to enter its submenu.

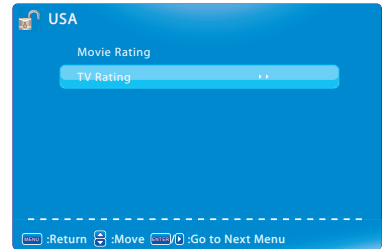

2. Press **▲** or **▼** to select your desired TV ratings level and press **◀** or **▶** to select the desired content check box.

The TV ratings level and content are defined as following:

TV ratings level	TV ratings content
• TV-Y (all children)	• D (suggestive dialog)
• TV-Y7 (older children)	• L (adult language)
• TV-G (general audience)	• S (sexual situations)
• TV-PG (guidance suggested)	• V (violence)
• TV-14 (strongly cautioned)	• FV (fantasy violence)
• TV-MA (mature audience)	

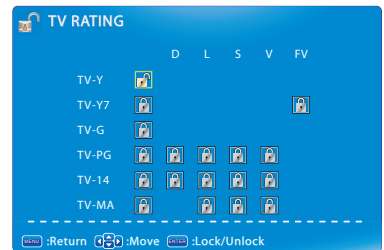

3. Press **ENTER** to lock (🔒) / unlock (🔓) your selection.
4. Press **EXIT** to exit the menu.

Using the LCD Display Features

To manage programs using the Canada Ratings system:

1. Press **MENU** to display the OSD main menu.
2. Press **◀** or **▶** to select **PARENTAL** menu, then press **ENTER** to enter the menu.
3. Enter the password.
4. Press **▲** or **▼** to select **V-CHIP**, then press **▶** to enter **V-CHIP** submenu.
5. Press **▲** or **▼** to select **Canada V-Chip**, then press **▶** to enter the Canada Rating system submenu.

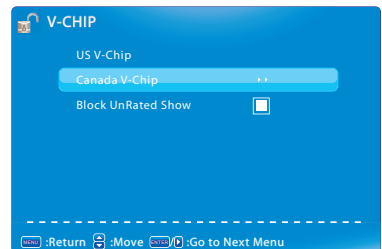
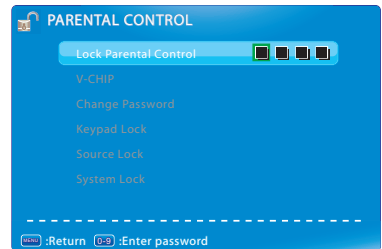

English Rating

1. Press **▲** or **▼** to select **English Rating**, then press **▶** to enter its submenu.
2. Press **▲** or **▼** to select your desired Canadian English rating level.
The Canadian English rating levels are defined as following:
 - C (children)
 - C8+ (children eight years and older)
 - G (general programming, suitable for all audiences)
 - PG (parental guidance)
 - 14+ (viewers and older)
 - 18+ (adult programming)
3. Press **ENTER** to lock (🔒) / unlock (🔓) your selection.
4. Press **EXIT** to exit the menu.

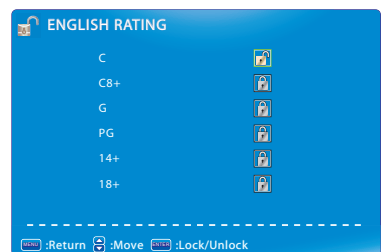
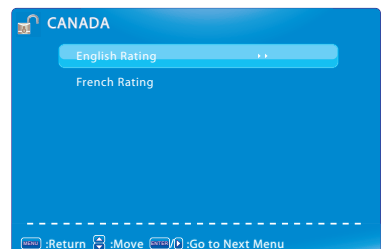

Using the LCD Display Features

French Rating

1. Press ▲ or ▼ to select **French Rating**, then press ► to enter its submenu.

2. Press ▲ or ▼ to select your desired Canadian French rating level.

The Canadian French rating levels are defined as following:

- G (general)
- 8 ans+ (children eight years and older)
- 13 ans+ (not appropriate for children of less than 13 years)
- 16 ans+ (not appropriate for children of less than 16 years)
- 18 ans+ (reserved to adults)

3. Press **ENTER** to lock (🔒) / unlock (🔓) your selection.

4. Press **EXIT** to exit the menu.

Blocking Unrated Movie Programs

To block the unrated movies programs:

1. Press **MENU** to display the OSD main menu.

2. Press ◀ or ▶ to select **PARENTAL** menu, then press **ENTER** to enter the menu.

3. Enter the password.

4. Press ▲ or ▼ to select **V-CHIP**, then press ► to enter **V-CHIP** submenu.

5. Press ▲ or ▼ to select **Block UnRated Show**.

6. Press **ENTER** to block/unblock all movies/programs that are not rated.

A ✓ icon indicates all movies/programs that are not rated have been blocked.

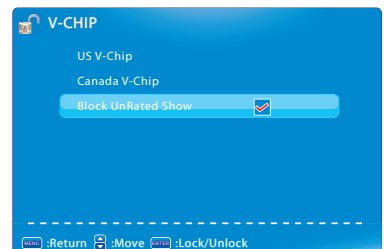
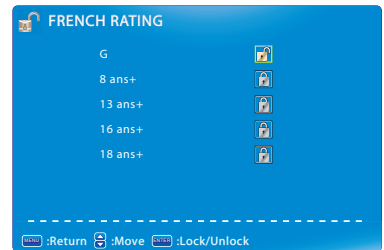
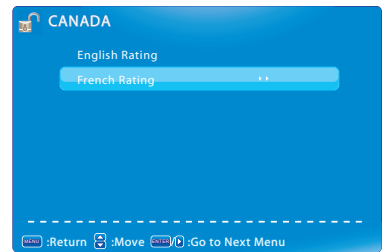

Using the LCD Display Features

Changing Password

To change a new password:

1. Press **MENU** to display the OSD main menu.
2. Press **◀** or **▶** to select **PARENTAL** menu, then press **ENTER** to enter the menu.
3. Enter the password.
4. Press **▲** or **▼** to select **Change Password**, then press **▶** to enter its submenu.

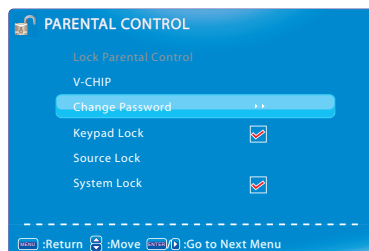

5. Enter the old password on **Old PIN**.
6. Enter your new password on **New PIN**.
7. Enter your new password again on **Confirm**.
The screen will return to the PARENTAL CONTROL menu. This indicates the password has been changed.
8. Press **EXIT** to exit the menu.

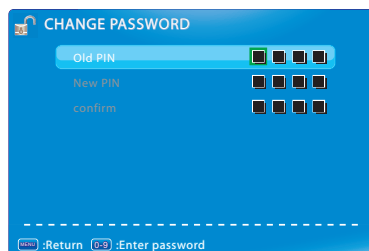

Blocking Selected Input Source

To block the selected input source:

1. Press **MENU** to display the OSD main menu.
2. Press **◀** or **▶** to select **PARENTAL** menu, then press **ENTER** to enter the menu.
3. Enter the password.
4. Press **▲** or **▼** to select **Source Lock**, then press **ENTER** to enter its submenu.

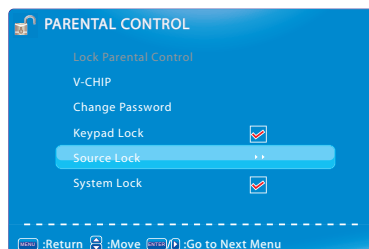

5. Press **▲** or **▼** to select the input source that you want to block.
6. Press **ENTER** to confirm.
A icon indicates the selected input source has been blocked.
7. Press **EXIT** to exit the menu.

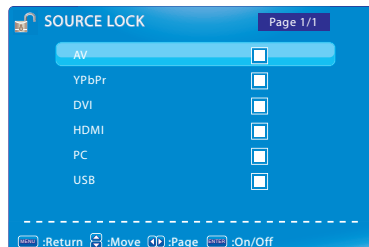

Using the LCD Display Features

Resetting to Factory Default Settings

To reset all setting to the factory default settings:

1. Press **MENU** to display the OSD main menu.
2. Press **◀** or **▶** to select **OTHERS** menu, then press **ENTER** to enter the menu.
3. Press **▲** or **▼** to select **All Reset**, then press **ENTER** to reset to the default settings.

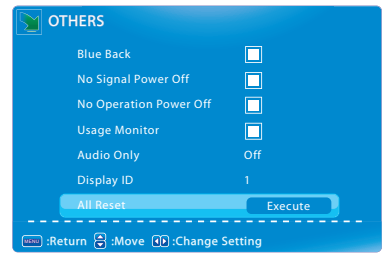

Display ID Setting

To set ID number to LCD display for RS232 function:

1. Press **MENU** to display the OSD main menu.
 2. Press **◀** or **▶** to select **OTHERS** menu, then press **ENTER** to enter the menu.
 3. Press **▲** or **▼** to select **Display ID**.
 4. Press **◀** or **▶** to set the ID number (1~98).
 5. Press **EXIT** to exit the menu.
- For details information, refer to the RS232 Protocol on page 29~36.

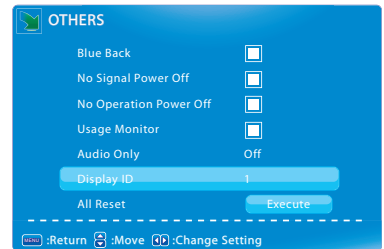

Customizing PC Display

Connect the PC and your LCD display using the VGA cable. See “Personal Computer” on page 9.

1. Press **SOURCE** to display the **Source Select** menu.
2. Press **▲** or **▼** to select **PC**, then press **ENTER** to confirm the setting.
3. Press **MENU** to display the OSD main menu.
4. Press **◀** or **▶** to select **PICTURE** menu, then press **ENTER** to enter the menu.
5. Press **▲** or **▼** to select **PC Settings**, then press **ENTER** to enter its submenu.
6. Press **▲** or **▼** to select **Auto Adjust**, **Horizontal Position**, **Vertical Position**, **Clock**, or **Phase**, and press **◀** or **▶** to adjust the setting.
7. Press **EXIT** to exit the menu.

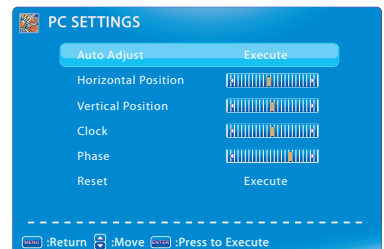
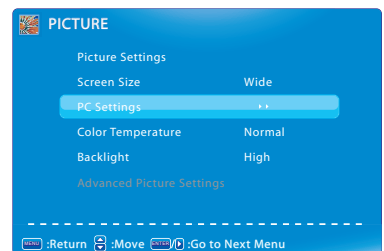

Using the LCD Display Features

Using USB Function

Your LCD display is equipped with a USB connector that enables you to view photos or listen to music stored on a USB storage device.

* USB only supports JPEG and MP3 files.

Multimedia support format

Multimedia Categories	File Extension	Decoder	Notes
Music	*.mp3	MPEG1 Audio LAYERIII (Not corresponding MP3 Pro)	Sampling Frequency [KHz] : 32 / 44.1 / 48 Bit Rate [kbit/s]: 32 / 40 / 48 / 56 / 64 / 80 / 96 / 112 / 128 / 160 / 192 / 224 / 256 / 320 / VBR
Photo	*.jpg	Baseline	Horizontal Max: less than 5000 Vertical Max: less than 5000 Horizontal Min: greater than 8 Vertical Min: greater than 8

1. Plug a USB device to the USB connector on the rear side of the LCD display.
2. Press **SOURCE** to display the **Source Select** menu.
3. Press **▲** or **▼** to select **USB**, then press **ENTER** to confirm the setting. The USB menu appears on the screen.

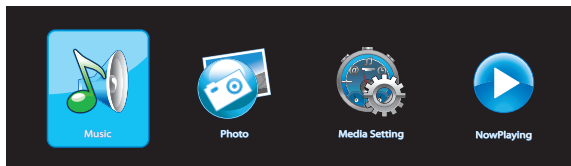

4. Press **◀** or **▶** to select the menu item, then press **ENTER**.
5. Press **EXIT** to return to the previous screen.

Playing Music

1. Press **◀** or **▶** to select **Music**, then press **ENTER**.

If there are several folders, press **▲** or **▼** to select the desired folder, then press **ENTER** to view the subfolder content.

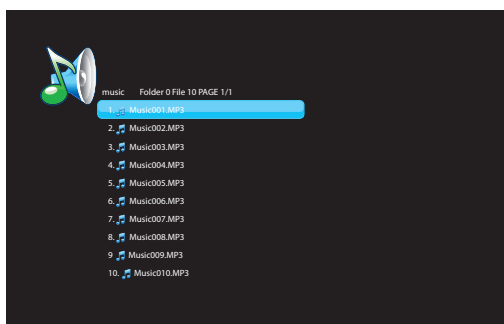

2. Press **▲** or **▼** to select a song, then press **ENTER** to play.
An automatic playback begins from the selected song.

Using the LCD Display Features

3. During the playback, do the following:

- To pause the playback, press ◀ or ▶ to select || icon, then press ENTER. Press ◀ or ▶ to select ▶ icon, then press ENTER to resume.
- To skip to previous song, press ◀ or ▶ to select ◀◀ icon, then press ENTER.
- To skip to next song, press ◀ or ▶ to select ▶▶ icon, then press ENTER.
- To stop the playback, press ◀ or ▶ to select ■ icon, then press ENTER.

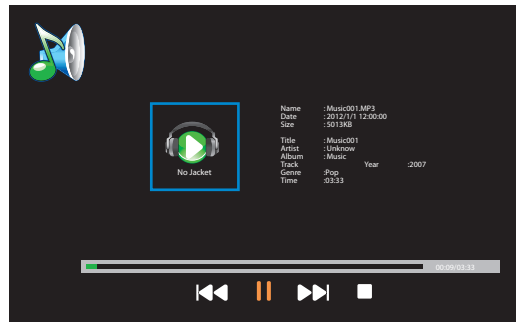

* You can directly view the playlist by selecting **NowPlaying**, then press ENTER.

Viewing Photos

1. Press ◀ or ▶ to select **Photo**, then press ENTER.

If there are several folders, press ▲ or ▼ to select the desired folder, then press ENTER to view the subfolder content.

2. Press ▲ or ▼ to select a photo, then press ENTER to view the photo in full screen.

- Press EXIT to stop the slide show.

Customizing Slide Show Settings

1. Press ◀ or ▶ to select **Media Setting**, then press ENTER.

2. Press ▲ or ▼ to select the menu item, and press ◀ or ▶ to adjust the setting.

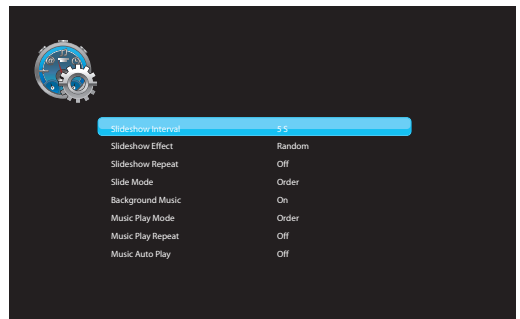

Menu item	Description
Slideshow Interval	Set the interval time between each slide displays (3 S / 5 S / 10 S / 30 S / 1 Min / 30 Min).
Slideshow Effect	Select the transition effect between each slide displays (Random / Off / Wipe Right / Wipe Left / Wipe Up / Wipe Down / Comb Side / Comb UpDown / Checker / Mosaic / Fade / Blind Right / Blind Left / Blind Up / Blind Down / Box In / Box Out / Slide in Right / Slide in Left / Slide in Up / Slide in Down).
Slideshow Repeat	Enable/Disable the slide show repetition (Off / On).
Slide Mode	Set the slide mode option (Order / Random).
Background Music	Enables/Disable background music during the slide show (On / Off).
Music Play Mode	Set music play mode option (Order / Random / Play One).
Music Play Repeat	Enable/Disable the music playback repetition (Off / On).
Music Auto Play	Enable/Disable the automatic music playback (Off / On).

Using the LCD Display Features

Adjusting On-Screen Display (OSD) Settings

1. Press **MENU** to display the OSD main menu.

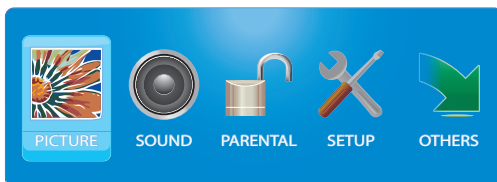

2. Press **◀** or **▶** to select the main menu, then press **ENTER** to enter the selected menu.

3. Press **▲** or **▼** to select the menu item, then press **◀** or **▶** to adjust or select the setting.

When selecting a menu item with a submenu (**▶▶**), press **▶** or **ENTER** to enter its submenu.

(“**▶▶**” will only appear when the menu item is highlighted)

4. Press **MENU** to return to the previous menu or press **EXIT** to exit the menu.

Picture Menu

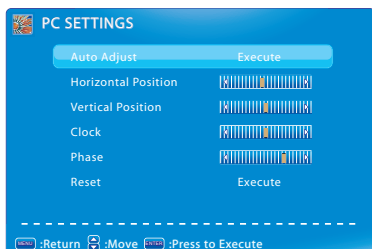
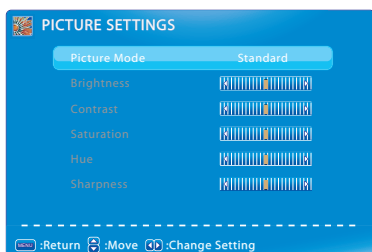
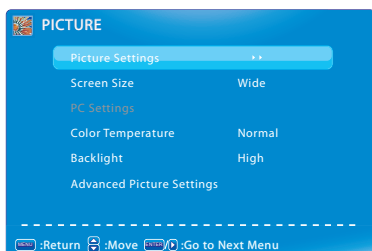

Menu item	Description
Picture Settings	Apply a preset picture mode optimized for different viewing conditions (Standard / Movie / User / Power Saving / Dynamic). * If Picture Settings is set to User , you can adjust the following settings: <ul style="list-style-type: none"> • Brightness: Adjust the brightness setting. • Contrast: Adjust the difference between the light and dark levels in the picture. • Saturation: Adjust the color detail of images. • Hue: Adjust the picture hue. • Sharpness: Adjust the sharpness of the edges of elements in the picture.
Screen Size	Select the aspect ratio of the display (Zoom / Normal / Wide / Cinema / Full 100%). * For Full 100% option, it is only available on HDMI/DVI input source.
PC Settings (only available on VGA source)	Adjust the PC display settings. <ul style="list-style-type: none"> • Auto Adjust: Synchronize the display automatically. • Horizontal Position: Move the screen position horizontally. • Vertical Position: Move the screen position vertically. • Clock: Adjust delay time of clock in order to reduce the noise of picture. • Phase: Adjust delay time of phase in order to reduce the noise of picture. • Reset: Reset to the default settings.
Color Temperature	Apply a preset color temperature setting (Normal / Warm / Cool).

Using the LCD Display Features

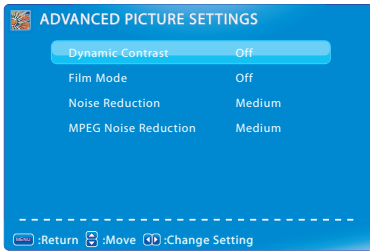

Menu item	Description
Backlight	Adjust the backlight that affects the overall brilliance of the picture (High / Medium / Low).
Advanced Picture Settings	Set additional picture settings: <ul style="list-style-type: none"> • Dynamic Contrast: Automatically enhance the image for greater picture details. • Film Mode: Produce smoother motion picture when viewing movies. • Noise Reduction: Reduce the noise level. • MPEG Noise Reduction: Reduce the noise level when viewing movies.

Sound Menu

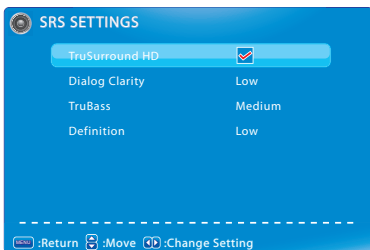
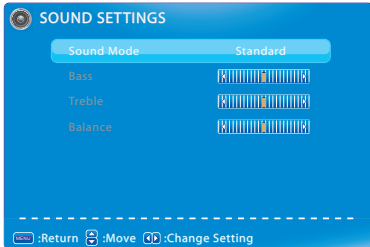
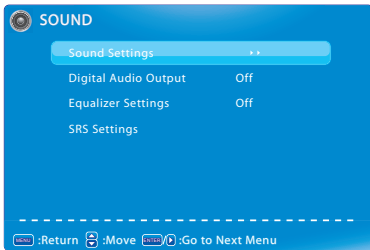

Menu item	Description
Sound Settings	Apply a preset audio option optimized for different sounding conditions (Standard / Soft / User / User SRS / Dynamic). <ul style="list-style-type: none"> * If Sound Settings is set to User, you can adjust the following settings: <ul style="list-style-type: none"> • Bass: Adjust the bass level to your preference. • Treble: Adjust the treble level to your preference. • Balance: Adjust the sound balance between the left and right speakers.
Digital Audio Output	Select the type of digital audio output to an external audio system (Off / PCM / Raw).
Equalizer Settings	Apply a preset equalizer setting (Off / Rock / Pop / Jazz / User SRS). <ul style="list-style-type: none"> * <i>When TruSurround HD is enabled, the Equalizer Settings will be set to User SRS.</i>
SRS Settings	Set the SRS sound settings. <ul style="list-style-type: none"> • TruSurround HD: Select to enable TruSurround HD feature. • Dialog Clarity: Set the dialog clarity level to ensure clear vocals. • TruBass: Set the bass output level to suit the capability of the speakers. • Definition: Set the definition level to deliver a high frequency sounds.

Using the LCD Display Features

Parental Control Menu

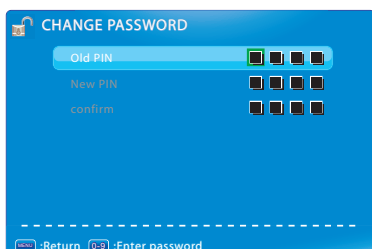
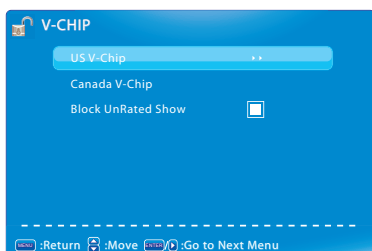

Menu item	Description
Lock Parental Control	Enter password to access Lock Parental Control menu. The default is “0000”.
V-CHIP	Set the channel settings. <ul style="list-style-type: none"> • US V-Chip: Set which USA TV/movie rating to lock for viewing. • Canada V-Chip: Set which Canada movie rating to lock for viewing. • Block UnRated Show: Block all unrated programs.
Change Password	Change the new password.
Keypad Lock	Select to lock the front panel keys operation.
Source Lock	Select the input source that you want to block.
System Lock	Enable/Disable the Lock Parental Control function.

Setup Menu

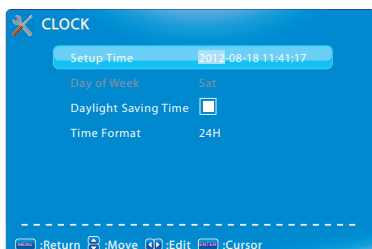
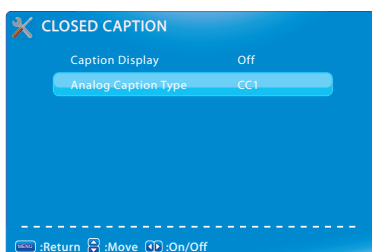

Menu item	Description
Closed Caption	Set Closed Caption (CC) settings. <ul style="list-style-type: none"> • Caption Display: Enable/Disable the caption display. • Analog Caption Type: Set the analog CC display type.
Menu Language	Select the on-screen menu language.
Clock	Set the time settings. <ul style="list-style-type: none"> • Setup Time: Set the current date and time. • Day of Week: Display the day of the week. • Daylight Saving Time: Set to turn on/off daylight saving. • Time Format: Select the time format. * <i>Daylight Saving Time is only available if Auto Clock is enabled.</i>
OSD Transparency	Set the OSD transparency level.
OSD Timer	Set the duration OSD menu stays visible on the screen.

Using the LCD Display Features

Others Menu

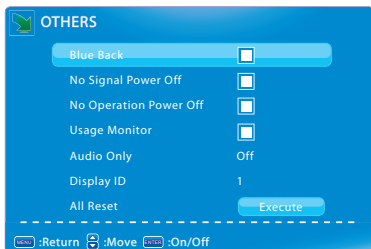

Menu item	Description
Blue Back	Select to enable the blue background in case of no signal.
No Signal Power Off	Select to set the LCD display to automatically turn off in case of no signal for 10 minutes.
No Operation Power Off	Select to set the LCD display to automatically turn off if it is left idle for 3 hours.
Usage Monitor	Select to calculate the overall monitor usage.
Audio Only	Output audio from the LCD display speakers but turn off the LCD display (Off / On).
Display ID	Set the LCD display ID for RS232 parameter.
All Reset	Select to restore the factory default settings.

Other Information

Troubleshooting

Please contact ViewSonic service team directly if you have questions, service needs, or require technical assistance related on the use of your LCD display.

Contact ViewSonic Service Team at:

<http://www.ViewSonic.com>

Or call our service team:

United States 1-800-688-6688

Canada 1-866-463-4775

Problem	Possible Solution
No power	<ul style="list-style-type: none">• Make sure the AC power cord is properly connected to the wall outlet.• Plug another electrical device (like a radio) to the power outlet to verify that the outlet is supplying the proper voltage.
No picture	<ul style="list-style-type: none">• Make sure that the cable connection to other components are properly installed.• Make sure that setup has been done correctly after connections.• Make sure the correct input is selected and the input signal is compatible.
Strange color, light color, or color misalignment	<ul style="list-style-type: none">• Ensure that the video cable is securely connected.• The picture may appear dim in a brightly lit room.• Adjust the display settings.• Check the input signal setting.
No sound	<ul style="list-style-type: none">• Check your audio connections to other components are properly installed.• The MUTE button may have been pressed, try pressing this button again.• Check your audio settings, your LCD display audio may be set to minimum.• Press VOL + on the remote control.

Other Information

Problem	Possible Solution
Remote control unit does not operate	<ul style="list-style-type: none">• Make sure the batteries are inserted correctly.• Batteries could be weak or dead. Replace with new batteries.• Check if there is a fluorescent light illuminated near the remote control sensor.• The path of the remote control beam may be blocked. Make sure the path is clear and that the remote control is aimed at the remote control sensor on the LCD display.• Press  on the remote control to see if you can turn on the LCD display.• Press MENU on the remote control to see if there is an OSD menu shown on the screen.• Press only one button at a time and it is the correct one for the operation you want to perform.
Unit cannot be operated	<ul style="list-style-type: none">• External influences such as lightning or static electricity may cause improper operation. In this case, operate the unit after first turning on the power of the LCD display and the AV System, or unplug the AC cord for 1 to 2 minutes, then replug again.
Power is cut off suddenly	<ul style="list-style-type: none">• Make sure the sleep timer is turned off.• Make sure the PC or video signal cable is connected properly.• The internal temperature of the unit has increased. Remove any objects blocking the vent or clean as necessary.
Picture is cut off/with sidebar screen	<ul style="list-style-type: none">• Make sure the video signal cable is connected properly.• Adjust the Screen Size setting on the Picture menu.• Press ASPECT repeatedly on the remote control to switch to the display mode you prefer.

Other Information

Specifications

Model		CDE3201LED
LCD (LED Backlight)	Screen Size	32-inch FHD 60Hz
	Aspect Ratio	16:9
Input signal	RGB	1 DVI, RGB analog (0.7/1.0 Vp-p, 75 ohms) Separate Sync, fh: 31.47-63.98 kHz, fv:59.8-70.09 Hz
	Video	1 composite RCA, 1 YPbPr component, 1 HDMI
	Audio	1 mini-stereo, 1 pair of RCA (L/R) stereo
	USB	JPEG / MP3 Format
Compatibility	PC	Up to 1920 x 1080 (CEA mode)
Speaker Output		5W x 2 @ THD=10% (max)
Audio Output		1 Earphone jack, 1 SPDIF (optical)
RS232 Output		RS232 communication
IR control Output		IR pass through signal (NEC 38KHz / RC5 38KHz)
Power	Voltage	AC 100~240V (50/60Hz)
Operating conditions	Temperature	0°C to + 40°C
	Humidity	20% to 90% (no condensation)
Storage condition	Temperature	-20°C to + 60°C
	Humidity	20% to 90% (no condensation)
Dimensions	Physical (W) x (L) x (H)	752.9 x 535.6 x 184.1 mm (29.64 x 21.1 x 7.25 in)
Weight	With stand	7.76kg (17.11lb)
	Without stand	7.24kg (15.96lb)
Regulations		UL/cUL, FCC-B (Doc-B), ICES-003, ENERGY STAR®, Mexico Energy
Power consumption	On	45 W (typ) / 65 W (max)
	Stand by	1 W
Warning: Do not set the graphics card in your computer to exceed these refresh rates; doing so may result in permanent damage to the LCD display.		

Note: Product Specifications are subject to change without notice.

RS232 Protocol

1. Introduction

This document describes the hardware interface spec and software protocols of RS232 interface communication between Viewsonic Commercial Display and PC or other control unit with RS232 protocol. The protocol divide into three sections:

- Set-Function
- Get-Function
- Remote control pass-through mode

✱ In below document, “PC” will represents all the control units that can sent or receive the RS232 protocol command.

2. Description

2.1 Hardware specification

Viewsonic LCD communication port in the rear side

- (1) Connector type: DSUB 9 Pin Male
- (2) Pin Assignment

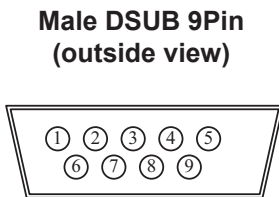

Pin #	Signal	Remark
1	NC	
2	RXD	Input to LCD Monitor
3	TXD	Output from LCD Monitor
4	NC	
5	GND	
6	NC	
7	NC	
8	NC	
9	NC	
frame	GND	

* Use of crossover (null modem) cable required for use with PC.

2.2 Communication Setting

- Baud Rate Select: 9600bps (fixed)
- Data bits: 8bits (fixed)
- Parity: None (fixed)
- Stop Bits: 1 (fixed)

2.3 Command Message Reference

PC sends to Monitor command packet followed by “CR”. Every time PC sends control command to the Monitor, the Monitor shall response as follows:

1. If the message is receives correctly it will send “+” (02Bh) followed by “CR” (00Dh)
2. If the message is receives incorrectly it will send “-” (02Dh) followed by “CR” (00Dh)

Other Information

3. Protocol

3.1 Set-Function Listing

The PC can control the LCD display for specific actions. The Set-Function command allows you to control the LCD display behavior in a remote sit through the RS232 port. The Set-Function packet format consists of 9 bytes.

Set-Function description:

- Length:** Total Byte of Message excluding “CR”
- ID:** Identification for each of LCD display
If we want to set all settings, ID can use “99” to achieve, and it will not have Reply command on this function.
The ID can be set via the OSD menu for each set.
- Command Type:** Identify command type,
“s” (0x73h) : Set Command
“+” (0x2Bh) : Valid command Reply
“-” (0x2Dh) : Invalid command Reply
- Command:** Function command code: One byte ASCII code
- Value[1~3]:** Three bytes ASCII that defines the value
- CR:** 0x0D

Set-Function format:

Send: (Command Type= “s”)

Name	Length	ID	Command Type	Command	Value1	Value2	Value3	CR
Byte Count	1 Byte	2 Byte	1 Byte	1 Byte	1 Byte	1 Byte	1 Byte	1 Byte
Bytes order	1	2~3	4	5	6	7	8	9

Reply: (Command Type= “+” or “-”)

Name	Length	ID	Command Type	CR
Byte Count	1 Byte	2 Byte	1 Byte	1 Byte
Bytes order	1	2~3	4	5

[NOTE] The reply for “Power on” command is the exception. It's 0x322B0D (2+<CR>).

Example1: Set Brightness as 76 for TV-02 and this command is valid

Send (Hex Format)

Name	Length	ID	Command Type	Command	Value1	Value2	Value3	CR
Hex	0x38	0x30 0x32	0x73	0x24	0x30	0x37	0x36	0x0D

Reply (Hex Format)

Name	Length	ID	Command Type	CR
Hex	0x34	0x30 0x32	0x2B	0x0D

Other Information

Example2: Set Brightness as 176 for TV-02 and this command is NOT valid.

Send (Hex Format)

Name	Length	ID	Command Type	Command	Value1	Value2	Value3	CR
Hex	0x38	0x30 0x32	0x73	0x24	0x31	0x37	0x36	0x0D

Reply (Hex Format)

Name	Length	ID	Command Type	CR
Hex	0x34	0x30 0x32	0x2D	0x0D

Set-function table

Set Function	Length	ID	Command Type (ASCII)	Command		Value Range (Three ASCII bytes)	Comments
				Code (ASCII)	Code (Hex)		
Power on/off(standby)	8		s	!	21	000: STBY 001: ON	
Input Select	8		s	“	22	000 : TV 001 : AV 002 : S-Video 003 : YPbPr 004 : HDMI 014: HDMI2 024: HDMI3 005 : DVI 006 : PC/VGA	1. No need for USB 2. For the case of two more same sources, the 2 nd digital is used to indicate the extension.
Contrast	8		s	#	23	000 ~ 100	
Brightness	8		s	\$	24	000 ~ 100	
Sharpness	8		s	%	25	000 ~ 100	
Color	8		s	&	26	000 ~ 100	
Tint	8		s	‘	27	000 ~ 100	
Color mode	8		s)	29	000: Normal 001: Warm 002: Cold 003: Personal	
Sound	8		s	-	2D	000: SRS Off 001: SRS On	
Bass	8		s	.	2E	000 ~ 100	
Treble	8		s	/	2F	000 ~ 100	
Balance	8		s	0	30	000 ~ 100	Sets Balance position
OSD language	8		s	2	32	000: English 001: French 002: Spanish	Extend the value for more supported languages
Power lock	8		s	4	34	000 : Unlock 001 : Lock	
Volume	8		s	5	35	000 ~ 100	

Other Information

Mute	8		s	6	36	000: OFF 001: ON (mute)	
Button lock	8		s	8	38	000: Unlock 001: Lock	
TV channel (DTV)	8		s	<	3C	For -0: 001~999 A00~F99 (1000~1599) For -k: 1 st and 2 nd char are same as -0 3 th char is CHAR[ASC(3th digi)+ k x 10]	It's channel OSD number but not frequency number.
TV channel (ATV)	8		s	=	3D	001~999	
Menu lock	8		s	>	3E	000: Unlock 001: Lock	
Number	8		s	@	40	000~009	
Key Pad	8		s	A	41	000: UP 001: DOWN 002: LEFT 003: RIGHT 004: ENTER 005: INPUT 006: MENU/EXIT	
Remote Control	8		s	B	42	000: Disable 001: Enable 002: Pass through	Disable: RCU has no effect on HDTV. Enabled: RCU controls the HDTV. This is the power up default on the HDTV. Pass through: RCU has no effect on HDTV and all RCU command codes are transmitted to FC via the RS232 port.
Setup wizard	8		s	C	43	000: Disable 001: Enable	Disable: to skip the initial setup wizard
Restore default	8		s	~	7E	000	Resets HDTV to factory setting

[NOTE]

1. Behavior at lock modes

Lock Mode	Behavior
Button Lock	1. Lock all buttons of front panel and RCU, except for "Power" 2. All the SET functions should be workable via RS32, even the ones with according hot key in RCU like Mute,...etc.
MENU Lock	1. Lock "MENU" key of front panel and RCU 2. The Factory and Hospitality modes should not be blocked for the model using MENU-combined key to enter these two modes. Alternative approach will be indicated separately if any limitation by model.

Other Information

POWER Lock	<ol style="list-style-type: none"> 1. Lock "POWER" key of front and RCU. 2. The SET_POWER on/off should be workable via RS232, but does not mean the POWER lock will be released under this case. 3. Can not be un-locked by reset in OSD setting 4. Will auto AC power-on in power-lock 5. Under power-lock, the set will not enter power saving when no PC signal and neither not turn off when no other video signals after 15min.
Remote control disable	Lock the keys on RCU, but keep the buttons of front panel workable.

2. Example for value setting of SET_TV channel DTV

012-0: 0x 30 31 32

012-1: 0x 30 31 42

1012-2: 0x 41 31 52

1512-3: 0x 46 31 62

3.2 Get-Function Listing

The PC can interrogate the LCD display for specific information. The Get-Function packet format consists of 9 bytes which is similar to the Set-Function packet structure. Note that the "Value" byte is always = 00.

Get-Function description:

Length:	Total Byte of Message excluding "CR"
ID:	Identification for each of LCD display
Command Type:	Identify command type, " g " (0x67h) : Get Command " r " (0x72h) : Valid command Reply " - " (0x2Dh) : Invalid command Reply
Command:	Function command code: One byte ASCII code
Value[1~3]:	Three bytes ASCII that defines the value
CR:	0x0D

Get-Function format:

Send: (Command Type= "g")

Name	Length	ID	Command Type	Command	Value1	Value2	Value3	CR
Byte Count	1 Byte	2 Byte	1 Byte	1 Byte	1 Byte	1 Byte	1 Byte	1 Byte
Bytes order	1	2~3	4	5	6	7	8	9

Reply: (Command Type= "r" or "-")

If the Command is valid, Command Type = "r"

Name	Length	ID	Command Type	Command	Value1	Value2	Value3	CR
Byte Count	1 Byte	2 Byte	1 Byte	1 Byte	1 Byte	1 Byte	1 Byte	1 Byte
Bytes order	1	2~3	4	5	6	7	8	9

Other Information

If the Command is Not valid, Command Type= “-.”

Name	Length	ID	Command Type	CR
Byte Count	1 Byte	2 Byte	1 Byte	1 Byte
Bytes order	1	2~3	4	5

**Example1: Get Brightness from TV-05 and this command is valid.
The Brightness value is 67.**

Send (Hex Format)

Name	Length	ID	Command Type	Command	Value1	Value2	Value3	CR
Hex	<u>0x38</u>	<u>0x30</u> <u>0x35</u>	<u>0x67</u>	<u>0x62</u>	<u>0x30</u>	<u>0x30</u>	<u>0x30</u>	<u>0x0D</u>

Reply (Hex Format)

Name	Length	ID	Command Type	Command	Value1	Value2	Value3	CR
Hex	<u>0x38</u>	<u>0x30</u> <u>0x35</u>	<u>0x72</u>	<u>0x62</u>	<u>0x30</u>	<u>0x36</u>	<u>0x37</u>	<u>0x0D</u>

Example2: Get Brightness from TV-05 , but the Brightness command ID is error and it is NOT in the command table.

Send (Hex Format)

Name	Length	ID	Command Type	Command	Value1	Value2	Value3	CR
Hex	<u>0x38</u>	<u>0x30</u> <u>0x35</u>	<u>0x67</u>	<u>0XD3</u>	<u>0x30</u>	<u>0x30</u>	<u>0x30</u>	<u>0x0D</u>

Reply (Hex Format)

Name	Length	ID	Command Type	CR
Hex	<u>0x34</u>	<u>0x30</u> <u>0x35</u>	<u>0x2D</u>	<u>0x0D</u>

Get-function table

Get Function	Length	ID	Command Type	Command		Response Range (Three ASCII bytes)	Comments
				Code (ASCII)	Code (Hex)		
Get-Contrast	8		g	a	61	000 ~ 100	
Get-Brightness	8		g	b	62	000 ~ 100	
Get-Sharpness	8		g	c	63	000 ~ 100	
Get-Color	8		g	d	64	000 ~ 100	
Get-Tint	8		g	e	65	000 ~ 100	
Get-Volume	8		g	f	66	000 ~ 100	

Other Information

Get-Mute	8		g	g	67	000: Off 001: On (muted)	
Get-Input select	8		g	j	6A	000~	See Set-function table
Get-Power status: ON/STBY	8		g	l	6C	001: ON 000: STBY	
Get-Remote control	8		g	n	6E	000: Disable 001: Enable 002: Pass through	Gets RCU mode status
Get-Power lock	8		g	o	6F	000: Unlock 001: Lock	
Get-Button lock	8		g	p	70	000: Unlock 001: Lock	
Get-Menu lock	8		g	q	71	000: Unlock 001: Lock	
Get-Setup wizard	8		g	s	73	000: Disable 001: Enable	
Get-ACK	8		g	z	7A	000	This command is used to test the communication link.

3.3 Remote Control Pass-through mode

When PC sets the LCD display to Remote Control Pass through mode, the LCD display shall send a 7 bytes packet (followed by “CR”) in response to RCU button activation. Note, that in this mode the RCU shall have no effect on the LCD display function. For example: “Volume+” will not change the volume in the LCD but only sends “Volume+” code to PC over the RS232 port.

IR Pass Through-Function format

Reply: (Command Type= “p”)

Name	Length	ID	Command Type	RCU Code1 (MSB)	RCU Code2 (LSB)	CR
Byte Count	1 Byte	2 Byte	1 Byte	1 Byte	1 Byte	1 Byte
Bytes order	1	2~3	4	5	6	7

Example1: Remote Control pass-through when “VOL+” key is pressed for TV-05

Reply (Hex Format)

Name	Length	ID	Command Type	RCU Code1 (MSB)	RCU Code2 (LSB)	CR
Hex	<u>0x36</u>	<u>0x30</u> <u>0x35</u>	<u>0x70</u>	<u>0x31</u>	<u>0x30</u>	<u>0x0D</u>

Key	Code (HEX)
1	01
2	02
3	03
4	04
5	05
6	06

Other Information

7	07
8	08
9	09
0	0A
-	0B
RECALL (LAST)	0C
	0D
	0E
ASPECT (ZOOM)	0F
VOLUME UP (+)	10
VOLUME DOWN (-)	11
MUTE	12
CHANNEL/PAGE UP (+)	13
CHANNEL/PAGE DOWN (-)	14
POWER	15
SOURCES (INPUTS)	16
	17
	18
SLEEP	19
MENU	1A
UP	1B
DOWN	1C
LEFT	1D
RIGHT	1E
OK (ENTER)	1F
EXIT	20
	21
	22
	23
	24
	25
	26
	27
	28
	29
	2A
	2B
	2C
	2D
	2E
	2F

[NOTE]

1. This IR-pass-through code is different with RCU key code
2. Special control sequence for POWER key under IR-pass through mode.
 - 2-1. When LCD display is OFF and receives the POWER code: The LCD display will turn on itself, then forward the POWER code to the host via RS232.
 - 2-2. When LCD display is ON and receives the POWER code: The LCD display will forward the POWER code to the host via RS232, then turns off itself.

Other Information

Customer Support

For technical support or product service, see the table below or contact your reseller.

Note: You will need the product serial number.

Use with other Wall-Mount kit may cause instability and possibly result in injury.

To find the perfect mount for CDE3201LED, please browse www.viewsonic.com or call our service team:
United States 1-800-688-6688, Canada 1-866-463-4775.

Country/Region	Website	T = Telephone F = FAX	Email
United States	www.viewsonic.com	T (Toll-Free)= 1-800-688-6688 T (Toll)= 1-424-233-2530 F= 1-909-468-3757	service.us@viewsonic.com
Canada	www.viewsonic.com	T (Toll-Free)= 1-866-463-4775 T (Toll)= 1-424-233-2533 F= 1-909-468-3757	service.ca@viewsonic.com
Latin America (Argentina)	www.viewsonic.com/la/	T= 0800-4441185	soporte@viewsonic.com
Latin America (Chile)	www.viewsonic.com/la/	T= 1230-020-7975	soporte@viewsonic.com
Latin America (Columbia)	www.viewsonic.com/la/	T= 01800-9-157235	soporte@viewsonic.com
Latin America (Mexico)	www.viewsonic.com/la/	T= 001-8882328722	soporte@viewsonic.com
Renta y Datos, 29 SUR 721, COL. LA PAZ, 72160 PUEBLA, PUE. Tel: 01.222.891.55.77 CON 10 LINEAS Electroser, Av Reforma No. 403Gx39 y 41, 97000 Mérida, Yucatán. Tel: 01.999.925.19.16 Other places please refer to http://www.viewsonic.com/la/soporte/index.htm#Mexico			
Latin America (Peru)	www.viewsonic.com/la/	T= 0800-54565	soporte@viewsonic.com

Limited Warranty

VIEWSONIC LCD Display

What the warranty covers:

ViewSonic warrants its products to be free from defects in material and workmanship, under normal use, during the warranty period. If a product proves to be defective in material or workmanship during the warranty period, ViewSonic will, at its sole option, repair or replace the product with a like product. Replacement product or parts may include remanufactured or refurbished parts or components.

How long the warranty is effective:

ViewSonic LCD displays are warranted for 3 years for all parts excluding the light source and 3 years for labor from the date of the first customer purchase.

Who the warranty protects:

This warranty is valid only for the first consumer purchaser.

What the warranty does not cover:

1. Any product on which the serial number has been defaced, modified or removed.
2. Damage, deterioration or malfunction resulting from:
 - a. Accident, misuse, neglect, fire, water, lightning, or other acts of nature, unauthorized product modification, or failure to follow instructions supplied with the product.
 - b. Repair or attempted repair by anyone not authorized by ViewSonic.
 - c. Any damage of the product due to shipment.
 - d. Removal or installation of the product.
 - e. Causes external to the product, such as electric power fluctuations or failure.
 - f. Use of supplies or parts not meeting ViewSonic's specifications.
 - g. Normal wear and tear.
 - h. Any other cause which does not relate to a product defect.
3. Any product exhibiting a condition commonly known as "image burn-in" which results when a static image is displayed on the product for an extended period of time.
4. Removal, installation, and set-up service charges.
5. When you mount it on the wall, the following must be noticed:
 - a. The accessories attached with this product are applicable for this product only.
 - b. When the product is mounted on the wall, holes and fixed screws will remain in the wall body.
 - c. Wall face may discolor when this product has been mounted on the wall for a long time.

How to get service:

1. For information about receiving service under warranty, contact ViewSonic Customer Support (please refer to Customer Support page). You will need to provide your product's serial number.
2. To obtain warranted service, you will be required to provide (a) the original dated sales slip, (b) your name, (c) your address, (d) a description of the problem, and (e) the serial number of the product.
3. Take or ship the product freight prepaid in the original container to an authorized ViewSonic service center or ViewSonic.
4. For additional information or the name of the nearest ViewSonic service center, contact ViewSonic.

Limitation of implied warranties:

There are no warranties, express or implied, which extend beyond the description contained herein including the implied warranty of merchantability and fitness for a particular purpose.

Exclusion of damages:

ViewSonic's liability is limited to the cost of repair or replacement of the product. ViewSonic shall not be liable for:

1. Damage to other property caused by any defects in the product, damages based upon inconvenience, loss of use of the product, loss of time, loss of profits, loss of business opportunity, loss of goodwill, interference with business relationships, or other commercial loss, even if advised of the possibility of such damages.
2. Any other damages, whether incidental, consequential or otherwise.
3. Any claim against the customer by any other party.

Effect of state law:

This warranty gives you specific legal rights, and you may also have other rights which vary from state to state. Some states do not allow limitations on implied warranties and/or do not allow the exclusion of incidental or consequential damages, so the above limitations and exclusions may not apply to you.

Sales outside the U.S.A. and Canada:

For warranty information and service on ViewSonic products sold outside of the U.S.A. and Canada, contact ViewSonic or your local ViewSonic dealer.

The warranty period for this product in mainland China (Hong Kong, Macao and Taiwan Excluded) is subject to the terms and conditions of the Maintenance Guarantee Card.

For users in Europe and Russia, full details of warranty provided can be found in www.viewsoniceurope.com under Support/Warranty Information.

4.3: ViewSonic LCD Display Warranty

LTV_LW01 Rev. 1C 06-25-07

Mexico Limited Warranty

VIEWSONIC LCD Display

What the warranty covers:

ViewSonic warrants its products to be free from defects in material and workmanship, under normal use, during the warranty period. If a product proves to be defective in material or workmanship during the warranty period, ViewSonic will, at its sole option, repair or replace the product with a like product. Replacement product or parts may include remanufactured or refurbished parts or components.

How long the warranty is effective:

ViewSonic LCD displays are warranted for 3 years for all parts excluding the light source and 3 years for labor from the date of the first customer purchase.

Who the warranty protects:

This warranty is valid only for the first consumer purchaser.

What the warranty does not cover:

1. Any product on which the serial number has been defaced, modified or removed.
2. Damage, deterioration or malfunction resulting from:
 - a. Accident, misuse, neglect, fire, water, lightning, or other acts of nature, unauthorized product modification, or failure to follow instructions supplied with the product.
 - b. Any damage of the product due to shipment.
 - c. Causes external to the product, such as electric power fluctuations or failure.
 - d. Use of supplies or parts not meeting ViewSonic's specifications.
 - e. Normal wear and tear.
 - f. Any other cause which does not relate to a product defect.
3. Any product exhibiting a condition commonly known as "image burn-in" which results when a static image is displayed on the product for an extended period of time.
4. Removal, installation, insurance, and set-up service charges.

How to get service:

For information about receiving service under warranty, contact ViewSonic Customer Support (Please refer to the attached Customer Support page). You will need to provide your product's serial number, so please record the product information in the space provided below on your purchase for your future use. Please retain your receipt of proof of purchase to support your warranty claim.

For Your Records

Product Name: _____

Model Number: _____

Document Number: _____

Serial Number: _____

Purchase Date: _____

Extended Warranty Purchase? _____ (Y/N)

If so, what date does warranty expire? _____

1. To obtain warranty service, you will be required to provide (a) the original dated sales slip, (b) your name, (c) your address, (d) a description of the problem, and (e) the serial number of the product.
2. Take or ship the product in the original container packaging to an authorized ViewSonic service center
3. Round trip transportation costs for in-warranty products will be paid by ViewSonic.

Limitation of implied warranties:

There are no warranties, express or implied, which extend beyond the description contained herein including the implied warranty of merchantability and fitness for a particular purpose.

Exclusion of damages:

ViewSonic's liability is limited to the cost of repair or replacement of the product. ViewSonic shall not be liable for:

1. Damage to other property caused by any defects in the product, damages based upon inconvenience, loss of use of the product, loss of time, loss of profits, loss of business opportunity, loss of goodwill, interference with business relationships, or other commercial loss, even if advised of the possibility of such damages.
2. Any other damages, whether incidental, consequential or otherwise.
3. Any claim against the customer by any other party.
4. Repair or attempted repair by anyone not authorized by ViewSonic.

Contact Information for Sales & Authorized Service (Centro Autorizado de Servicio) within Mexico:

Name, address, of manufacturer and importers:

México, Av. de la Palma #8 Piso 2 Despacho 203, Corporativo Interpalmas,

Col. San Fernando Huixquilucan, Estado de México

Tel: (55) 3605-1099

<http://www.viewsonic.com/la/soporte/index.htm>

Other Information

NÚMERO GRATIS DE ASISTENCIA TÉCNICA PARA TODO MÉXICO: 001.866.823.2004	
<p>Hermosillo: Distribuciones y Servicios Computacionales SA de CV. Calle Juarez 284 local 2 Col. Bugambilias C.P: 83140 Tel: 01-66-22-14-9005 E-Mail: disc2@hmo.megared.net.mx</p>	<p>Villahermosa: Compumantenimientos Garantizados, S.A. de C.V. AV. GREGORIO MENDEZ #1504 COL, FLORIDA C.P. 86040 Tel: 01 (993) 3 52 00 47 / 3522074 / 3 52 20 09 E-Mail: compumantenimientos@prodigy.net.mx</p>
<p>Puebla, Pue. (Matriz): RENTA Y DATOS, S.A. DE C.V. Domicilio: 29 SUR 721 COL. LA PAZ 72160 PUEBLA, PUE. Tel: 01(52).222.891.55.77 CON 10 LINEAS E-Mail: datos@puebla.megared.net.mx</p>	<p>Veracruz, Ver.: CONEXION Y DESARROLLO, S.A DE C.V. Av. Americas # 419 ENTRE PINZÓN Y ALVARADO Fracc. Reforma C.P. 91919 Tel: 01-22-91-00-31-67 E-Mail: gacosta@qplus.com.mx</p>
<p>Chihuahua Soluciones Globales en Computación C. Magisterio # 3321 Col. Magisterial Chihuahua, Chih. Tel: 4136954 E-Mail: Cefeo@soluglobales.com</p>	<p>Cuernavaca Compusupport de Cuernavaca SA de CV Francisco Leyva # 178 Col. Miguel Hidalgo C.P. 62040, Cuernavaca Morelos Tel: 01 777 3180579 / 01 777 3124014 E-Mail: aquevedo@compusupportcva.com</p>
<p>Distrito Federal: QPLUS, S.A. de C.V. Av. Coyoacán 931 Col. Del Valle 03100, México, D.F. Tel: 01(52)55-50-00-27-35 E-Mail : gacosta@qplus.com.mx</p>	<p>Guadalajara, Jal.: SERVICRECE, S.A. de C.V. Av. Niños Héroes # 2281 Col. Arcos Sur, Sector Juárez 44170, Guadalajara, Jalisco Tel: 01(52)33-36-15-15-43 E-Mail: mmiranda@servicrece.com</p>
<p>Guerrero Acapulco GS Computación (Grupo Sesicom) Progreso #6-A, Colo Centro 39300 Acapulco, Guerrero Tel: 744-48-32627</p>	<p>Monterrey: Global Product Services Mar Caribe # 1987, Esquina con Golfo Pérsico Fracc. Bernardo Reyes, CP 64280 Monterrey N.L. México Tel: 8129-5103 E-Mail: aydeem@gps1.com.mx</p>
<p>MÉRIDA: ELECTROSER Av Reforma No. 403Gx39 y 41 Mérida, Yucatán, México CP97000 Tel: (52) 999-925-1916 E-Mail: rrrb@sureste.com</p>	<p>Oaxaca, Oax.: CENTRO DE DISTRIBUCION Y SERVICIO, S.A. de C.V. Murguía # 708 P.A., Col. Centro, 68000, Oaxaca Tel: 01(52)95-15-15-22-22 Fax: 01(52)95-15-13-67-00 E-Mail: gpotai2001@hotmail.com</p>
<p>Tijuana: STD Av Ferrocarril Sonora #3780 L-C Col 20 de Noviembre Tijuana, Mexico</p>	<p>FOR USA SUPPORT: ViewSonic Corporation 381 Brea Canyon Road, Walnut, CA. 91789 USA Tel: 800-688-6688 (English); 866-323-8056 (Spanish); Fax: 1-800-685-7276 E-Mail: http://www.viewsonic.com</p>

4.3: ViewSonic Mexico Limited Warranty

LTV_LW02 Rev. 1A 06-25-07



ViewSonic®