

# ViewSonic®



---

## **PJD8653ws/PJD8353s** **DLP Projector** **User Guide**

---

**IMPORTANT:** Please read this User Guide to obtain important information on installing and using your product in a safe manner, as well as registering your product for future service. Warranty information contained in this User Guide will describe your limited coverage from ViewSonic Corporation, which is also found on our web site at <http://www.viewsonic.com> in English, or in specific languages using the Regional selection box in the upper right corner of our website. "Antes de operar su equipo lea cuidadosamente las instrucciones en este manual"

---

**Model No. VS14956/VS14991**

# Compliance Information

## FCC Statement

This device complies with part 15 of FCC Rules. Operation is subject to the following two conditions: (1) this device may not cause harmful interference, and (2) this device must accept any interference received, including interference that may cause undesired operation.

This equipment has been tested and found to comply with the limits for a Class B digital device, pursuant to part 15 of the FCC Rules. These limits are designed to provide reasonable protection against harmful interference in a residential installation. This equipment generates, uses, and can radiate radio frequency energy, and if not installed and used in accordance with the instructions, may cause harmful interference to radio communications. However, there is no guarantee that interference will not occur in a particular installation. If this equipment does cause harmful interference to radio or television reception, which can be determined by turning the equipment off and on, the user is encouraged to try to correct the interference by one or more of the following measures:

- Reorient or relocate the receiving antenna.
- Increase the separation between the equipment and receiver.
- Connect the equipment into an outlet on a circuit different from that to which the receiver is connected.
- Consult the dealer or an experienced radio/TV technician for help.

**Warning:** You are cautioned that changes or modifications not expressly approved by the party responsible for compliance could void your authority to operate the equipment.

## For Canada

- This Class B digital apparatus complies with Canadian ICES-003.
- Cet appareil numérique de la classe B est conforme à la norme NMB-003 du Canada.

## CE Conformity for European Countries

 The device complies with the EMC Directive 2004/108/EC and Low Voltage Directive 2006/95/EC.

## Following information is only for EU-member states:

The mark is in compliance with the Waste Electrical and Electronic Equipment Directive 2002/96/EC (WEEE).

The mark indicates the requirement NOT to dispose the equipment including any spent or discarded batteries or accumulators as unsorted municipal waste, but use the return and collection systems available.

If the batteries, accumulators and button cells included with this equipment, display the chemical symbol Hg, Cd, or Pb, then it means that the battery has a heavy metal content of more than 0.0005% Mercury or more than, 0.002% Cadmium, or more than 0.004% Lead.



# Important Safety Instructions

1. Read these instructions.
2. Keep these instructions.
3. Heed all warnings.
4. Follow all instructions.
5. Do not use this unit near water.
6. Clean with a soft, dry cloth.
7. Do not block any ventilation openings. Install the unit in accordance with the manufacturer's instructions.
8. Do not install near any heat sources such as radiators, heat registers, stoves, or other devices (including amplifiers) that produce heat.
9. Do not defeat the safety purpose of the polarized or grounding-type plug. A polarized plug has two blades with one wider than the other. A grounding type plug has two blades and a third grounding prong. The wide blade and the third prong are provided for your safety. If the provided plug does not fit into your outlet, consult an electrician for replacement of the obsolete outlet.
10. Protect the power cord from being walked on or pinched particularly at plugs. Convenience receptacles and the point where they exit from the unit. Be sure that the power outlet is located near the unit so that it is easily accessible.
11. Only use attachments/accessories specified by the manufacturer.
12. Use only with the cart, stand, tripod, bracket, or table specified by the manufacturer, or sold with the unit. When a cart is used, use caution when moving the cart/unit combination to avoid injury from tipping over. 
13. Unplug this unit when unused for long periods of time.
14. Refer all servicing to qualified service personnel. Servicing is required when the unit has been damaged in any way, such as: if the power-supply cord or plug is damaged, if liquid is spilled onto or objects fall into the unit, if the unit is exposed to rain or moisture, or if the unit does not operate normally or has been dropped.

# Declaration of RoHS2 Compliance

This product has been designed and manufactured in compliance with Directive 2011/65/EU of the European Parliament and the Council on restriction of the use of certain hazardous substances in electrical and electronic equipment (RoHS2 Directive) and is deemed to comply with the maximum concentration values issued by the European Technical Adaptation Committee (TAC) as shown below:

Substance	Proposed Maximum Concentration	Actual Concentration
Lead (Pb)	0.1%	< 0.1%
Mercury (Hg)	0.1%	< 0.1%
Cadmium (Cd)	0.01%	< 0.01%
Hexavalent Chromium (Cr <sup>6+</sup> )	0.1%	< 0.1%
Polybrominated biphenyls (PBB)	0.1%	< 0.1%
Polybrominated diphenyl ethers (PBDE)	0.1%	< 0.1%

Certain components of products as stated above are exempted under the Annex of the RoHS2 Directives as noted below:

Examples of exempted components are:

1. Mercury in compact fluorescent lamps not exceeding 5 mg per lamp and in other lamps not specifically mentioned in the Annex of RoHS2 Directive
2. Lead in glass of cathode ray tubes, electronic components, fluorescent tubes, and electronic ceramic parts (e.g. piezoelectric devices)
3. Lead in high temperature type solders (i.e. lead-based alloys containing 85% by weight or more lead)

Lead as an alloying element in steel containing up to 0.35% lead by weight, aluminium containing up to 0.4% lead by weight and as a copper alloy containing up to 4% lead by weight

# Copyright Information

Copyright © ViewSonic® Corporation, 2013. All rights reserved.

Macintosh and Power Macintosh are registered trademarks of Apple Inc.

Microsoft, Windows, Windows NT, and the Windows logo are registered trademarks of Microsoft Corporation in the United States and other countries.

ViewSonic, the three birds logo, OnView, ViewMatch, and ViewMeter are registered trademarks of ViewSonic Corporation.

VESA is a registered trademark of the Video Electronics Standards Association. DPMS and DDC are trademarks of VESA.

PS/2, VGA and XGA are registered trademarks of International Business Machines Corporation.

Disclaimer: ViewSonic Corporation shall not be liable for technical or editorial errors or omissions contained herein; nor for incidental or consequential damages resulting from furnishing this material, or the performance or use of this product.

In the interest of continuing product improvement, ViewSonic Corporation reserves the right to change product specifications without notice. Information in this document may change without notice.

No part of this document may be copied, reproduced, or transmitted by any means, for any purpose without prior written permission from ViewSonic Corporation.

## Product Registration

To fulfill possible future product needs, and to receive additional product information as it becomes available, please visit your region section on ViewSonic's website to register your product online.

The ViewSonic CD also provides an opportunity for you to print the product registration form. Upon completion, please mail or fax to a respective ViewSonic office. To find your registration form, use the directory ".\CD\Registration". Registering your product will best prepare you for future customer service needs.

Please print this user guide and fill the information in the "For Your Records" section. Your LCD displays serial number is located on the rear side of the display.

For additional information, please see the "Customer Support" section in this guide.

### For Your Records

<b>Product Name:</b>	PJD8653ws/PJD8353s ViewSonic DLP Projector
<b>Model Number:</b>	VS14956/VS14991
<b>Document Number:</b>	PJD8653ws/PJD8353s_UG_ENG Rev. 1A 01-17-13
<b>Serial Number:</b>	_____
<b>Purchase Date:</b>	_____

### Product disposal at end of product life

The lamp in this product contains mercury which can be dangerous to you and the environment. Please use care and dispose of in accordance with local, state or federal laws.

ViewSonic respects the environment and is committed to working and living green. Thank you for being part of Smarter, Greener Computing. Please visit ViewSonic website to learn more.

USA & Canada: <http://www.viewsonic.com/company/green/recycle-program/>

Europe: <http://www.viewsoniceurope.com/uk/support/recycling-information/>

Taiwan: <http://recycle.epa.gov.tw/recycle/index2.aspx>

## Notes on the AC Power Cord

AC Power Cord must meet the requirement of countries where you use this projector. Please confirm your AC plug type with the graphics below and ensure that the proper AC Power Cord is used. If the supplied AC Power Cord does not match your AC outlet, please contact your sales dealer. This projector is equipped with a grounding type AC line plug. Please ensure that your outlet fits the plug. Do not defeat the safety purpose of this grounding type plug. We highly recommend using a video source device also equipped with a grounding type AC line plug to prevent signal interference due to voltage fluctuations.

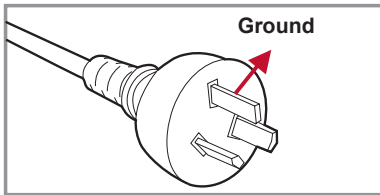

For Australia and Mainland China

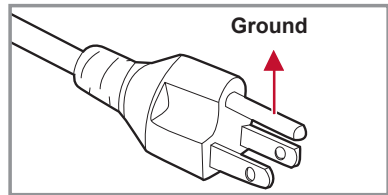

For the U.S.A and Canada

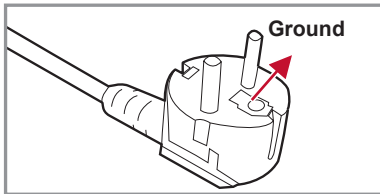

For Continental Europe

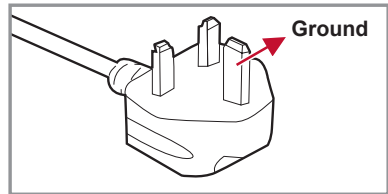

For the U.K.

# Table of Contents

## Introduction 7

Package Overview .....	7
Product Overview .....	8
Main Unit.....	8
Control Panel .....	9
Connection Ports .....	10
Remote Control.....	11

## Installation 12

Connecting to Computer/Notebook.....	12
Connecting to Video Sources.....	13
Powering On/Off the Projector .....	14
Powering On the Projector.....	14
Powering Off the Projector.....	15
LED Indicator Messages.....	15
Adjusting the Projected Image .....	16
Adjusting the Projector's Height.....	16
Adjusting the Projector's Focus .....	17
Adjusting Projection Image Size .....	17

## User Controls 19

Using the Control Panel .....	19
Using the Remote Control .....	20
On-screen Display Menus .....	22
How to operate .....	22
Structure .....	23
Picture.....	25
Screen .....	27
Setting.....	29
Setting   Security.....	31
Volume.....	33
Options .....	34
Options   Lamp Settings.....	36
3D .....	37
Interactive .....	38

LAN.....	39
Timer.....	40
Web Management.....	41

## Appendices 48

Troubleshooting.....	48
Image Problems.....	48
Projector Problems .....	51
Remote Control Problems .....	51
Sound Problems .....	51
3D Problems .....	51
On Screen Messages .....	52
Compatibility Modes.....	53
Replacing the lamp.....	57
Replacing and cleaning the optional dust filter.....	58
Ceiling Mount Installation .....	59
Specifications .....	60

# Introduction

## Package Overview

Unpack and inspect the box contents to ensure all parts listed below are in the box. If something is missing, please contact our customer service.

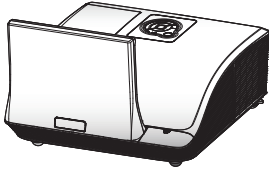

Projector with lens cap



Remote Control



AAA Batteries x 2  
(For remote control)

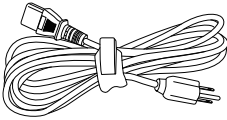

AC Power Cord

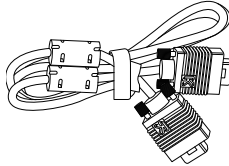

VGA Cable

### Documentation:

- User's Guide (DVD)
- Quick Start Card



- Due to different applications in each Country, some regions may have different accessories.



# Product Overview

## Main Unit

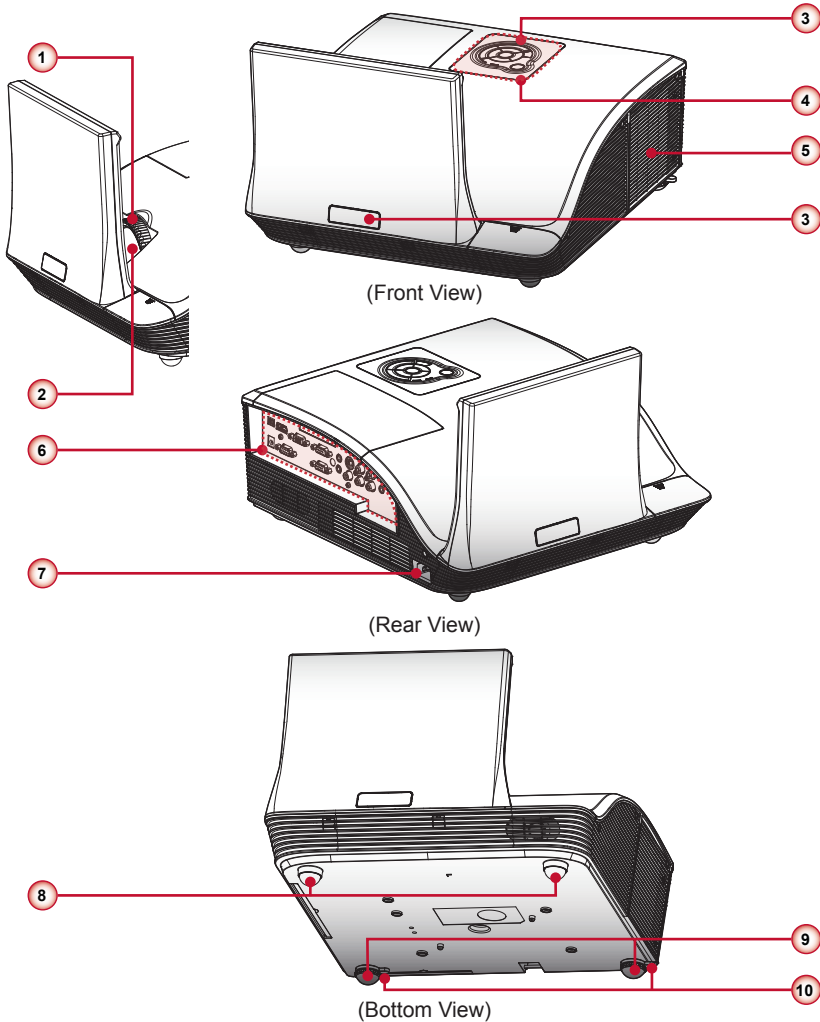

1. Focus Ring

2. Lens

3. IR Receiver

4. Control Panel

5. Lamp Cover

6. Input / Output Connection Ports

7. Power Socket



8. Elevator Feet

9. Elevator Feet

10. Elevator Feet Spacer

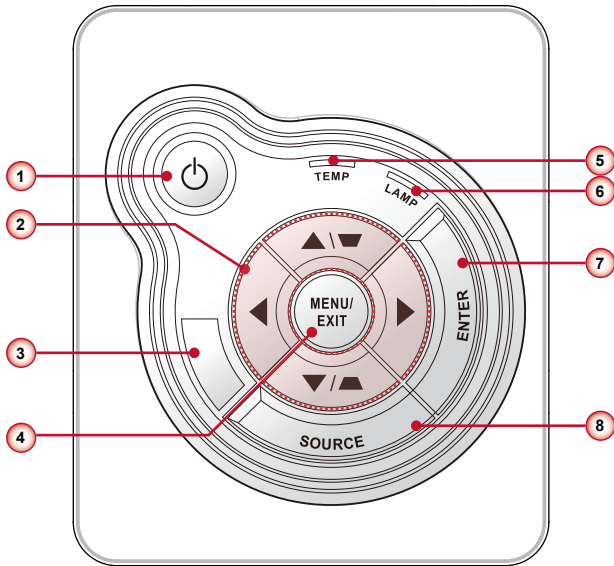
## Control Panel



1.  Power key / Power LED
2. Four directional select keys / Keystone  
3. IR Receiver
4. Menu / Exit
5. Temp (Temperature) LED
6. Lamp LED
7. Enter
8. Source

## Connection Ports

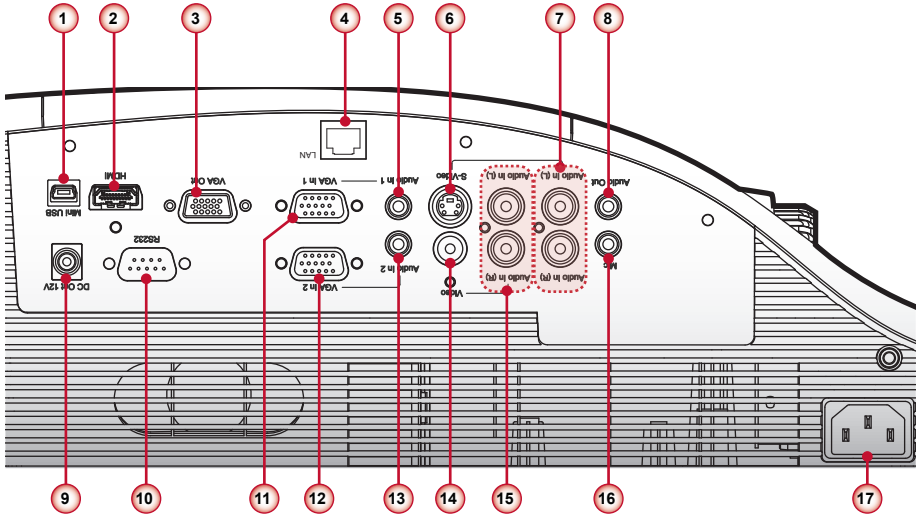

1. Mini USB Connector
2. HDMI Connector
3. VGA Output Connector
4. LAN Connector
5. Audio In 1 Connector (For VGA In 1 Connector)
6. S-Video Connector
7. Left/Right RCA Audio Input Connector (For S-Video Connector)
8. Audio Output Connector
9. 12V Trigger Relay Connector (12V, 250mA)
10. RS232 Connector
11. VGA In 1 Connector
12. VGA In 2 Connector
13. Audio In 2 Connector (For VGA In 2 Connector)
14. Composite Video Input Connector
15. Left/Right RCA Audio Input Connector (For Composite Video Input Connector)
16. 3.5mm Microphone Input Connector
17. Power Socket

# Remote Control

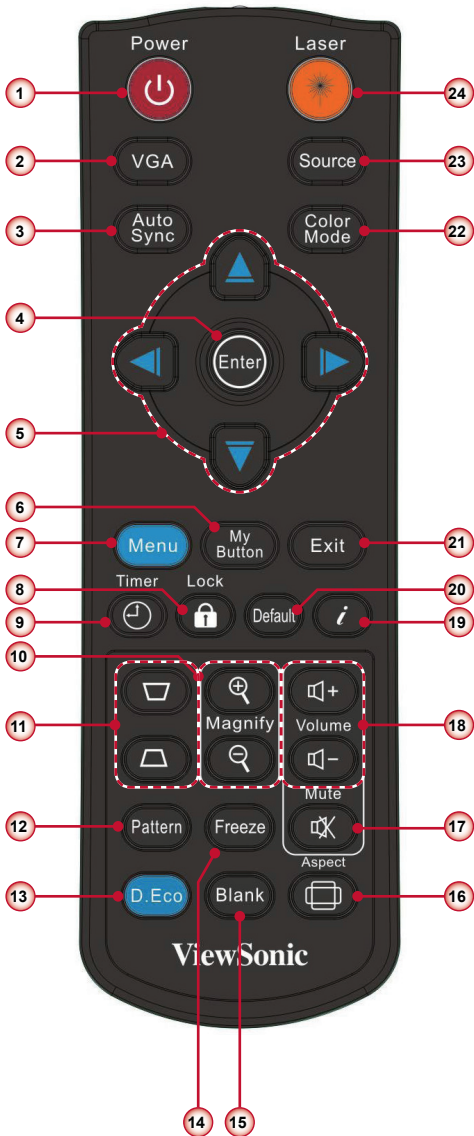

1. Power
2. VGA
3. Auto Sync
4. Enter
5. Four Directional Select Keys
6. My Button
7. Menu
8. Lock
9. Timer
10. Magnify +/-
11. Keystone
12. Pattern
13. D.Eco
14. Freeze
15. Blank
16. Aspect
17. Mute
18. Volume +/-
19. Information (i)
20. Default
21. Exit
22. Color Mode
23. Source
24. Laser

# Installation

## Connecting to Computer/Notebook

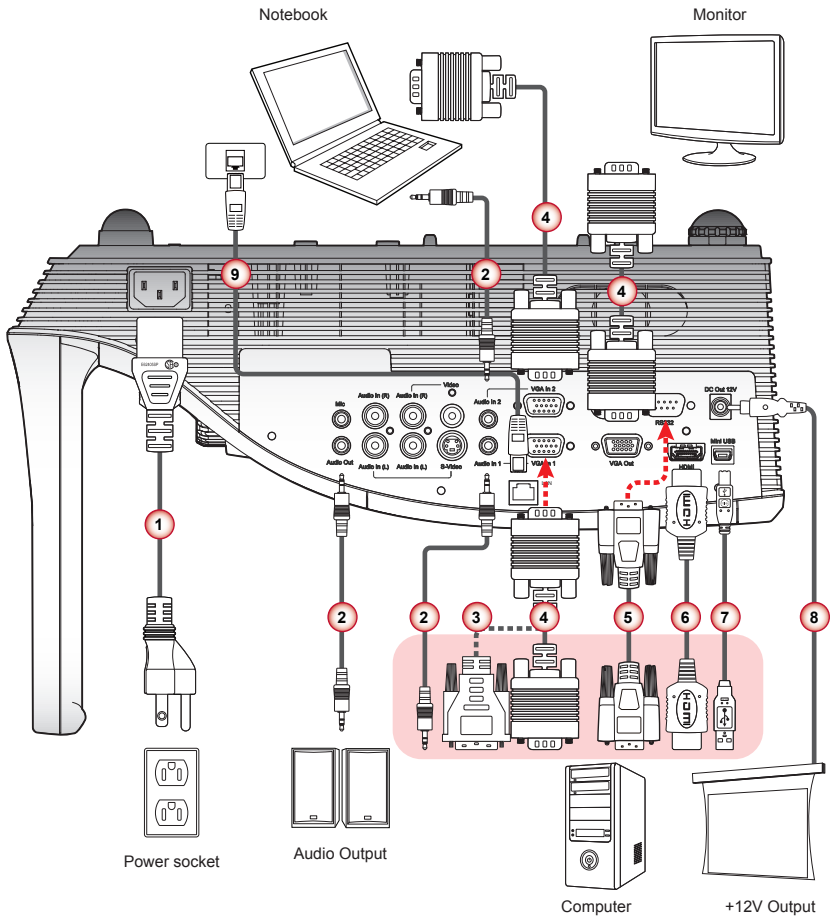

1. Power Cord
2. Audio Cable \*
3. VGA to DVI-A Cable \*
4. VGA Cable
5. RS232 Cable \*
6. HDMI Cable \*
7. USB Cable \*
8. 12V DC Jack \*
9. Network Cable \*



- Due to the difference in applications for each country, some regions may have different accessories.
- \* Optional accessory

# Connecting to Video Sources

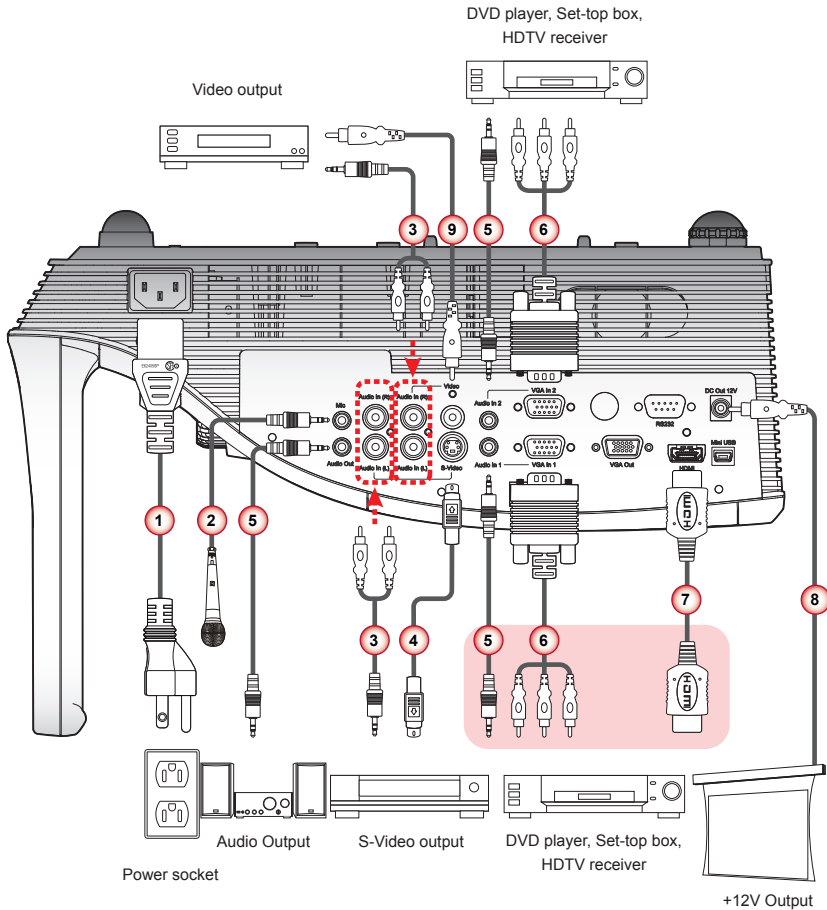

1. Power Cord
2. Microphone Cable \*
3. Audio Cable Jack/RCA \*
4. S-Video Cable \*
5. Audio Cable \*
6. VGA to HDTV (RCA) Cable \*
7. HDMI Cable \*
8. 12V DC Jack \*
9. Composite Video Cable \*

**NOTE** ■ Due to the difference in applications for each country, some regions may have different accessories.  
 ■ \* Optional accessory

# Powering On/Off the Projector

## Powering On the Projector

1. Securely connect the power cord and signal cable. When connected, the Power LED will turn red.
2. Turn on the lamp by pressing “⏻” button on the control panel or on the remote control. The Power LED will turn blue.
3. Turn on your source that you want to display on the screen (computer, notebook, video player, etc). The projector will detect the source automatically and will display on the screen.
4. If you connected multiple sources at the same time, press the “Source” button on the remote control to switch between the inputs.

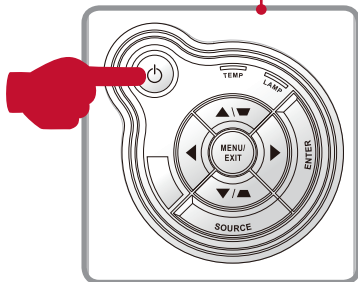
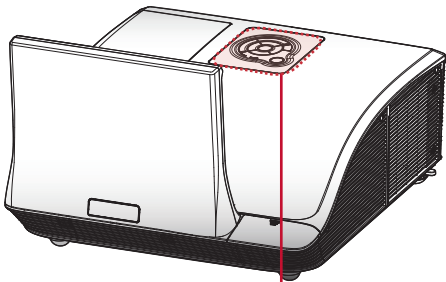

or



## Powering Off the Projector

1. Press the “⏻” button on the control panel or on the remote control to turn off the projector. The following message will be displayed on the screen. Press the “⏻” button again to confirm.

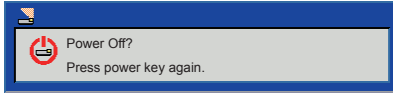

2. The Power LED will turn red and blink rapidly after the projector is turned off. And the fans will continue to operate for about 10 seconds to ensure that the system cools properly.
3. Once the system has finished cooling, the Power LED will stop blinking and turn solid red to indicate standby mode.
4. It is now safe to unplug the power cord.

## LED Indicator Messages

Message	Lamp LED (Red)	Temp LED (Red)	Power LED (Red)	Power LED (Blue)
Power Plug	Flash ON to OFF 100ms	Flash ON to OFF 100ms	Flash ON to OFF 100ms	-
Standby	-	-	ON	-
Power button ON	-	-	-	ON
Cooling state	-	-	0.5 second H(ON), 0.5 second L(OFF) flashing	-
Power button OFF: Cooling completed; Standby Mode	-	-	ON	-
Firmware download	ON	ON	ON	-
Thermal sensor error, OSD showing as below: 1. Make sure air in and outlets are not blocked. 2. Make sure the environment temperature is under 40 degree C.	-	ON	-	ON
Fan lock error, OSD showing as below: The projector will switch off automatically.	-	0.5 second H(On), 0.5 second L(Off) flashing	-	ON
Lamp error (Lamp, Lamp driver, Color wheel)	ON	-	-	ON



# Adjusting the Projected Image

## Adjusting the Projector's Height

*The projector is equipped with elevator feet for adjusting the image height.*

- To raise the image:

Use screw in feet to raise the image to the desired height angle and fine-tune the display angle. ❶

- To lower the image:

Use screw in feet to lower the image to the desired height angle and fine-tune the display angle. ❷

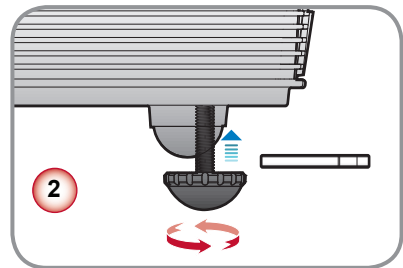
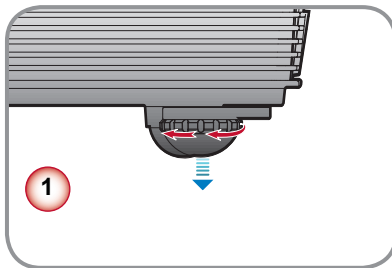
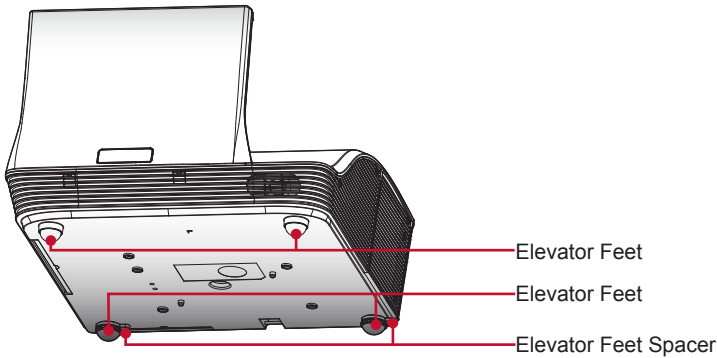

## Adjusting the Projector's Focus

To focus the image, rotate the focus ring until the image is clear.

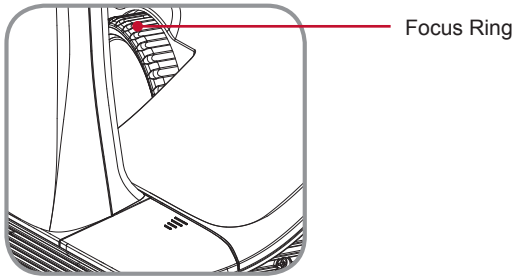

## Adjusting Projection Image Size

Refer to the graphics and table show as below to determine the screen size and projection distance.

- Adjusting the vertical image position

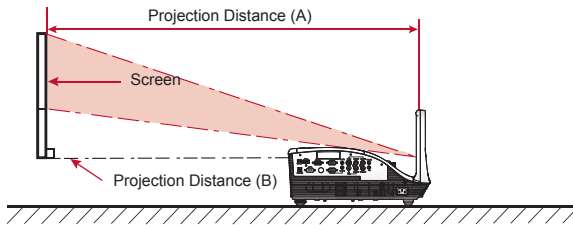

WXGA Series					
Screen Size (16:10)		Projection Distance (A)		Projection Distance (B)	
Diagonal (inch)	mm	Inch	mm	Inch	mm
70	1778	20.4	517	7.2	182
80	2032	23.5	596	10.3	262
87.2	2215	25.8	655	12.6	320
90	2286	26.7	677	13.5	343
100	2540	29.9	759	16.7	424



- $Projection\ Distance\ A(mm) = Screen\ size(mm) \times 0.296$ , Tolerance is around 3.1%  
Ex:  $Projection\ Distance\ (655mm) = Screen\ size(2215mm) \times 0.296$
- This table is for user's reference only.

XGA Series					
Screen Size (4:3)		Projection Distance (A)		Projection Distance (B)	
Diagonal (inch)	mm	Inch	mm	Inch	mm
60	1524	20.6	522	7.4	187
70	1778	24.3	617	11.1	282
77	1956	27.0	684	13.7	349
80	2032	28.0	712	14.9	378
90	2286	31.6	802	18.4	468



- *Projection Distance A(mm)=Screen size(mm) x 0.3496, Tolerance is around 3.1%,  
Ex: Projection Distance (684mm)=Screen size(1956mm) x 0.3496*
- *This table is for user's reference only.*

# User Controls



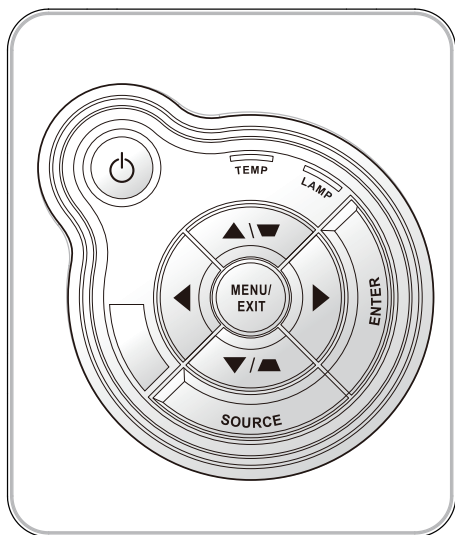



## Using the Control Panel

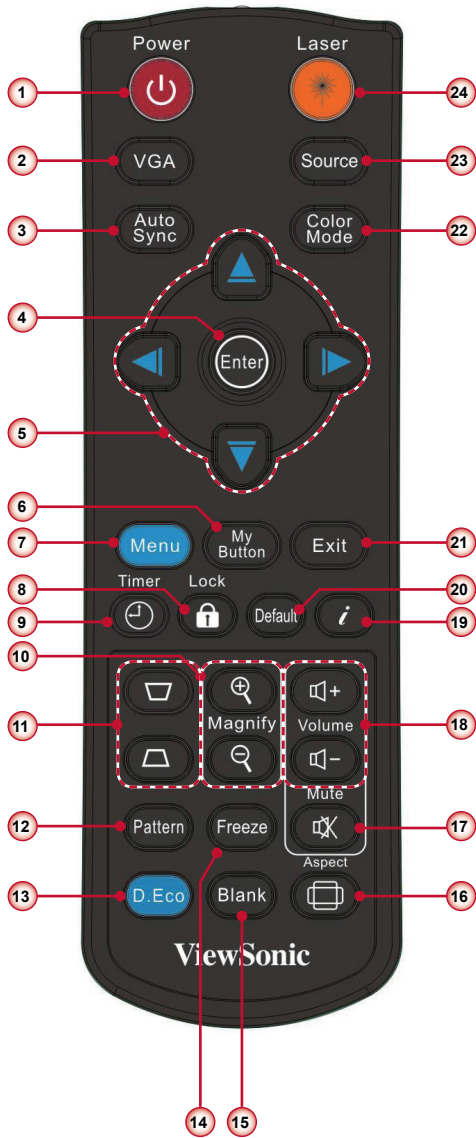

Name	Description
Power  / Power LED	Turn the projector on/off. Indicate the projector's status.
Menu / Exit	Launch the on-screen display (OSD) / Exit a menu.
Enter	Confirm a selected item.
Source	Select an input signal.
Four Directional Select Keys	<ol style="list-style-type: none"><li>1. Use ▲▼◀▶ to select items or make adjustments to your selection.</li><li>2. ▲/▼act as short hot keys for Keystone +/- adjustment.</li></ol>
Lamp LED	Indicate the projector's lamp status.
Temp LED	Indicate the projector's temperature status.

# Using the Remote Control



Name		Description
1	Power 	Power on/off the projector.
2	VGA	Switch to VGA-A/VGA-B source.
3	Auto Sync	Automatically synchronize the PC analog timing to its optimized condition.
4	Enter	Activate or confirm the selected OSD function.
5	Four Directional Select Keys	Press     direction buttons to select items or make adjustments.
6	My Button	Switch to the common functions.
7	Menu	Launch or Exit the on-screen display(OSD).
8	Lock	Lock the keypad function in Projector control panel, excluding the Power key.
9	Timer	Set the prestation timer function. Options are: "Timer Period", "Timer Display", "Timer Position", "Timer counting direction" and "Start Counting." (refer to page 42)
10	Magnify +/-	Zoom in and out the image.
11	Keystone 	Adjust image until the sides are vertical.
12	Pattern	Display test patterns.
13	D.Eco	Select to operate under economic mode. Press it again to switch to normal mode. When this function is activating, the lamp power consumption is dimming 30% and extend the lamp life.
14	Freeze	Press to freeze the image. Press it again to un-freeze the image.
15	Blank	Hide the screen picture. Press again to display screen picture.
16	Aspect	Use this function to choose your desired aspect ratio.
17	Mute	Mute the volume of speakers and audio out. Press again and switch to normal volume.
18	Volume +/-	Increase / decrease audio volume.
19	Information (i)	Display the projector information.
20	Default	Reset all settings to factory default.
21	Exit	Exit current OSD page or exit OSD menu.
22	Color Mode	Select the presets optimized for various types of images.
23	Source	Select an input signal.
24	Laser	Press to use laser pointer.

# On-screen Display Menus

The Projector has multilingual On-screen Display menus that allow you to make image adjustments and change a variety of settings. The projector will automatically detect the source.

## How to operate

1. To open the OSD menu, press the “Menu” button on the remote control or on the control panel.
2. When OSD is displayed, use the ◀▶▲▼ buttons to select the desired item and adjust the settings by the ◀▶ buttons.
3. If the setting has  icon, you could press the ▶ button to enter another sub menu. Press the “Menu” button to close the sub menu after adjustment.
4. After adjusting the settings, press the “Menu” button to go back to the main menu.
5. To exit, press the “Menu” button again. The OSD menu will be closed and the projector will automatically save the new settings.

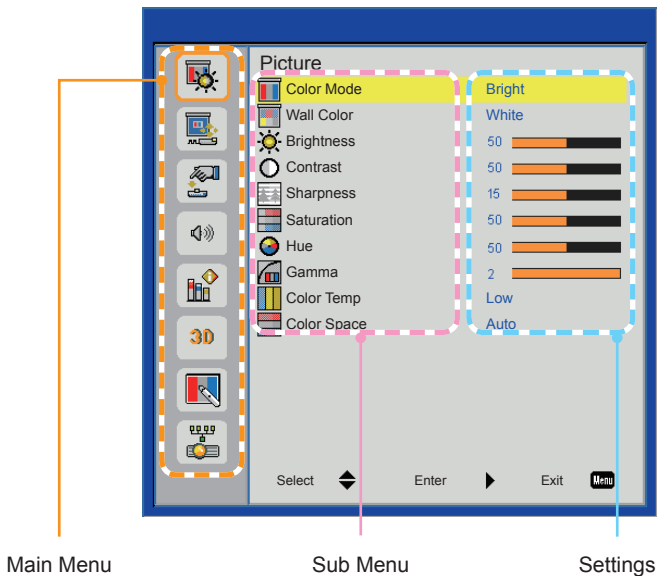

# Structure

Main Menu	Sub Menu	Settings	
<b>PICTURE</b>	Color Mode	Brightest / PC / Movie / Game / User	
	Wall Color	White / Light Yellow / Light Blue / Pink / Dark Green	
	Brightness	0~100	
	Contrast	0~100	
	Sharpness	0~31	
	Saturation	0~100	
	Hue	0~100	
	Gamma	0~3	
	Color Temp.	Low / Mid / High	
	Color Space	AUTO / RGB / YUV	
	<b>SCREEN</b>	Aspect Ratio	AUTO / 4:3 / 16:9 / 16:10
		Phase	0~31
		Clock	-50~50
H. Position		-10~10	
V. Position		-10~10	
Digital Zoom		1~10	
V Keystone		-20~20	
Ceiling Mount	Front / Front Ceiling / Rear / Rear Ceiling		
<b>SETTING</b>	Language	English / Deutsch / Français / Italiano / Español / Português / Polski / Русский / Svenska / Norsk / 简体中文 / 日本語 / 한국어 / Türkçe / 繁體中文 / Nederlands / عربي	
	Menu Location		
	Closed Caption	Off / CC1 / CC2 / CC3 / CC4	
	VGA Out (Standby)	Off / On	
	LAN/Wireless(Standby)	Off / On	
	Auto Screen(12V out)	Off / On	
	Test Pattern	Off / On	
	Security	Security	
		Change Password	000000
	Reset	No / Yes	
	<b>Audio</b>	Mute	Off / On
		Volume	0~32
		Microphone Volume	0~32
<b>OPTIONS</b>	Logo	Default / User	
	Logo Capture		
	Auto source	Off / On	
	Input	HDMI / VGA-A / VGA-B / S-Video / COMPOSITE	
	Auto Power Off (min)	0~120	
	Lamp Setting	Lamp Hours Used (Normal)	
		Lamp Hours Used (ECO)	
		Lamp Life Reminder	Off / On
		Lamp Power Mode	ECO / Normal / Extreme Dimming
		Clear Lamp Hours	No / Yes
	Dynamic Black	Off / On	
	High Altitude	Off / On	
	Dust Filter Reminder	Filters Remind(Hour)	
Cleaning Up Reminder		No / Yes	
Information	Model Name / SNID / Source / Resolution / Software Version / Color Space / Aspect Ratio		



Main Menu	Sub Menu	Settings	
<b>3D</b>	3D	AUTO / Off / On	
	3D Invert	Off / On	
	3D Format	Frame Packing / Side-by-Side (Half) / Top and Bottom / Frame Sequential / Field Sequential	
	1080p @ 24	96Hz / 144Hz	
<b>Interactive</b>	Interactive Settings	Off / IR Camera	
<b>LAN</b>	LAN Settings	DHCP	Off / On
		IP Address	
		Subnet mask	
		Gateway	
		DNS	
		Store	No / Yes
	Reset	No / Yes	

# Picture

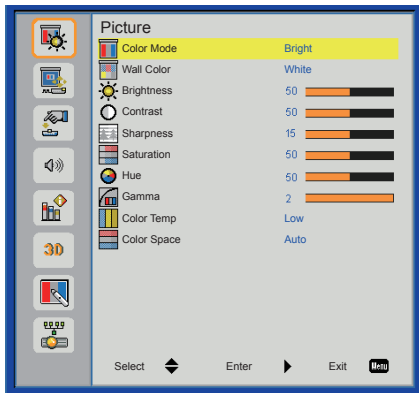

## Color Mode

There are many factory presets optimized for various types of images. Use the ◀ or ▶ button to select the item.

- ▶ Brightest: For brightness optimization.
- ▶ PC: For meeting presentation.
- ▶ Movie: For playing video content.
- ▶ Game: For game content.
- ▶ User: Memorize user's settings.

## Wall Color

Use this function to choose a proper color according to the wall. It will compensate the color deviation due to the wall color to show the correct image tone.

## Brightness

Adjust the brightness of the image.

- ▶ Press the ◀ button to darken image.
- ▶ Press the ▶ button to lighten the image.

## Contrast

The Contrast controls the difference between the lightest and darkest parts of the picture. Adjusting the contrast changes the amount of black and white in the image.

- ▶ Press the ◀ button to decrease the contrast.
- ▶ Press the ▶ button to increase the contrast.

## Sharpness

Adjust the sharpness of the image.

- ▶ Press the ◀ button to decrease the sharpness.
- ▶ Press the ▶ button to increase the sharpness.

## Saturation

Adjust a video image from black and white to fully saturated color.

- ▶ Press the ◀ button to decrease the amount of saturation in the image.
- ▶ Press the ▶ button to increase the amount of saturation in the image.

## Hue

Adjust the color balance of red and green.

- ▶ Press the ◀ button to increase the amount of green in the image.
- ▶ Press the ▶ button to increase the amount of red in the image.



- *"Sharpness", "Saturation" and "Hue" functions are only supported under video mode.*

## Gamma

Effects the representation of dark scenery. With greater gamma value, dark scenery will look brighter.

## Color Temp.

Adjust the color temperature. At higher temperature, the screen looks colder; at lower temperature, the screen looks warmer.

## Color Space

Select an appropriate color matrix type from Auto, RGB or YUV.

# Screen



## Aspect Ratio

- ▶ Auto: Keep the image with original width-height ratio and maximize the image to fit native horizontal or vertical pixels.
- ▶ 4:3: The image will be scaled to fit the screen and displayed using a 4:3 ratio.
- ▶ 16:9: The image will be scaled to fit the width of the screen and the height adjusted to display the image using a 16:9 ratio.
- ▶ 16:10: The image will be scaled to fit the width of the screen and the height adjusted to display the image using a 16:10 ratio.

## Phase

Synchronize the signal timing of the display with the graphic card. If the image appears to be unstable or flickers, use this function to correct it.

## Clock

Change the display data frequency to match the frequency of your computer's graphic card. Use this function only if the image appears to flicker vertically.

## H. Position

- ▶ Press the ◀ button to move the image left.
- ▶ Press the ▶ button to move the image right.

## V. Position

- ▶ Press the ◀ button to move the image down.
- ▶ Press the ▶ button to move the image up.



■ "H. Position" and "V. Position" ranges will depend on input source.

## Digital Zoom

Press the ◀ button to reduce the size of an image.

Press the ▶ button to magnify an image on the projection screen.

## V Keystone

Press the ◀ or ▶ button to adjust image distortion vertically. If the image looks trapezoidal, this option can help make the image rectangular.

## Ceiling Mount

- ▶ Front: The image is projected straight on the screen.
- ▶ Front Ceiling: This is the default selection. When selected, the image will turn upside down.
- ▶ Rear: When selected, the image will appear reversed.
- ▶ Rear Ceiling: When selected, the image will appear reversed in upside down position.

# Setting

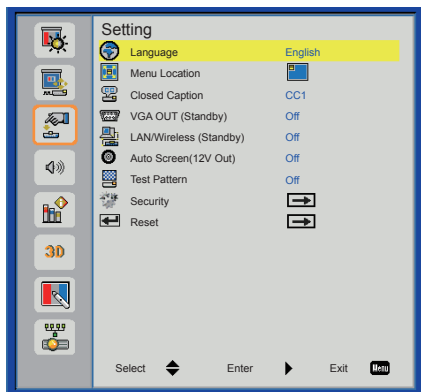

## Language

Choose the multilingual OSD menu. Press the ◀ or ▶ button into the sub menu and then use the ▲ or ▼ button to select your preferred language. Press ▶ on the remote control to finalize the selection.



## Menu Location

Choose the menu location on the display screen.

## Closed Caption

Use this function to enable close caption menu. Select an appropriate closed captions option: Off, CC1, CC2, CC3, CC4.

## VGA OUT (Standby)

Choose "On" to enable VGA OUT connection.

## LAN/Wireless (Standby)

Choose "On" to enable LAN/Wireless connection. Choose "Off" to disable LAN/Wireless connection.

### Auto Screen (12V Out)

Choose "On", the down/up move of electronic screen will be related with power on/off of Projector.

### Test Pattern

Display a test pattern.

### Security

Refer next page.

### Reset

Choose "Yes" to return the parameters on all menus to the factory default settings.

## Setting | Security

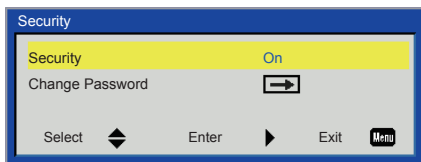

### Security

- ▶ On: Choose “On” to use security verification when turning on the projector.
- ▶ Off: Choose “Off” to be able to switch on the projector without password verification.

### Change Password

- ▶ First time:
  - Press the ► button to set the password.
  - The password has to be 6 digits.
  - Use the ▲ or ▼ on the remote control to select your new password on the screen and then press ► to confirm it.
- ▶ Change Password:
  - Use the ▲ or ▼ on the remote control to enter your current password on the screen and then press ► to confirm it.
  - Enter a new password (6 digits in length) then press “Enter” to confirm it.
  - Enter the new password again and press “Enter” to confirm it.
- ▶ If the incorrect password is entered for 3 times, the projector will automatically shut down.
- ▶ If you have forgotten your password, please contact your local office for support.



NOTE

- Password default value is "0000" (first time).

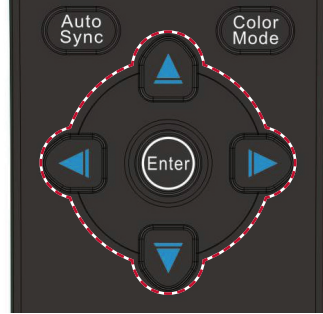
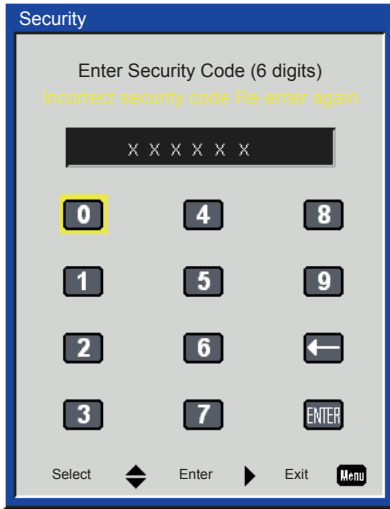

# Volume

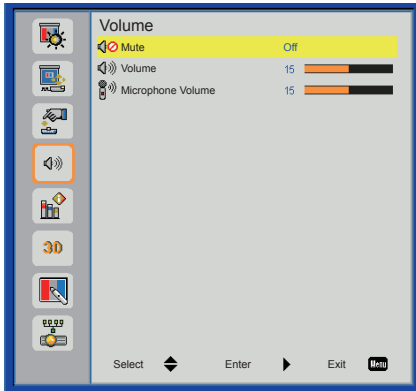

## Mute

- ▶ Choose “On” to turn mute on.
- ▶ Choose “Off” to turn mute off.

## Volume

- ▶ Press the ◀ button to decrease the volume.
- ▶ Press the ▶ button to increase the volume.

## Microphone Volume

- ▶ Press the ◀ button to decrease the microphone Volume.
- ▶ Press the ▶ button to increase the microphone Volume.

# Options

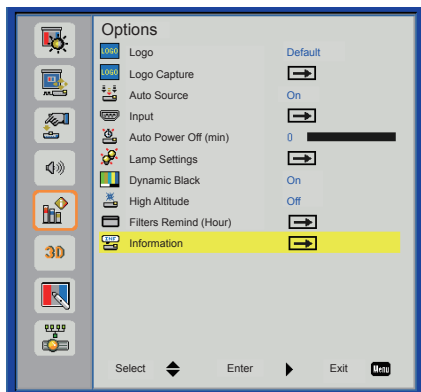

## Logo

Use this function to set the desired startup screen. If changes are made they will take effect the next time the projector is powered on.

- ▶ Default: The default startup screen.
- ▶ User: Use stored picture from “Logo Capture” function.

## Logo Capture

Press ▶ button to capture an image of the picture currently displayed on screen.

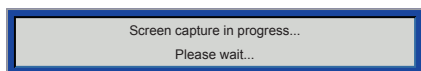

- For successful logo capture, please ensure that the onscreen image does not exceed the projector's native resolution. (WXGA:1280x800).
- “Logo Capture” is not available when 3D is enabled.
- Before active this function, it is recommended that “Aspect Ratio” is set to the “Auto”.

## Auto Source

- ▶ On: The projector will search for other signals if the current input signal is lost.
- ▶ Off: The projector will only search current input connection.

## Input

Press ▶ button to enable/disable input sources. The projector will not search for inputs that are not selected.

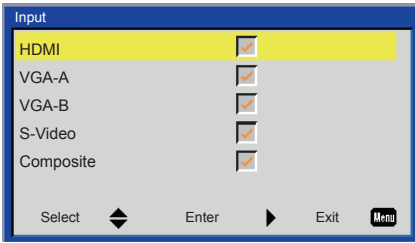

### Auto Power Off (min)

Sets the countdown timer interval. The countdown timer will start, when there is no signal being sent to the projector. The projector will automatically power off when the countdown has finished (in minutes).

### Lamp Setting

Refer to page 36.

### Dynamic Black

- ▶ On: The pictures with the optimum contrast will be displayed by automatically providing aperture compensation and signal compensation to suit the pictures concerned.
- ▶ Off: Turn off this function.



- "Dynamic Black" is available when "Color Mode" is set to "Movie".
- "Dynamic Black" is not available when "3D" or "Interactive" is enabled.
- When "Dynamic Black" is available, "Lamp Power Mode" selection is not available.

### High Altitude

- ▶ On: The built-in fans automatically run at a variable speed according to the internal temperature.
- ▶ Off: The built-in fans run at high speed. Select this option when using the projector at altitudes above 5000 feet/1524 meters or higher.

### Filters Remind (Hour)

- ▶ Filters Remind (Hour): Set the filter reminder time
- ▶ Cleaning Up Reminder: Select "Yes" to reset the dust filter hour counter after replacing or cleaning the dust filter.

### Information

Display the projector information for model name, SNID, source, resolution, software version, color space and aspect ratio on the screen.

## Options | Lamp Settings

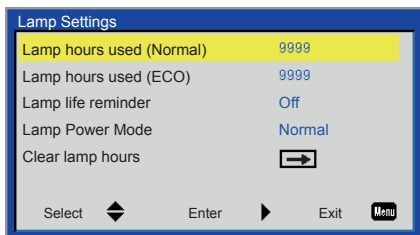

### Lamp Hours Used (Normal)

Display the projection time of normal mode.

### Lamp Hours Used (ECO)

Display the projection time of ECO mode.

### Lamp Life Reminder

- ▶ On: Choose "On" to show the lamp end of life warning message.
- ▶ Off: Choose "Off" to hide the lamp end of life warning message.

### Lamp Power Mode

- ▶ Normal: Normal mode.
- ▶ ECO: Use this function to dim the projector lamp which will lower power consumption and extend the lamp life.

### Clear Lamp Hours

Choose "Yes" to reset the lamp hour counter after replacing the lamp.

## 3D

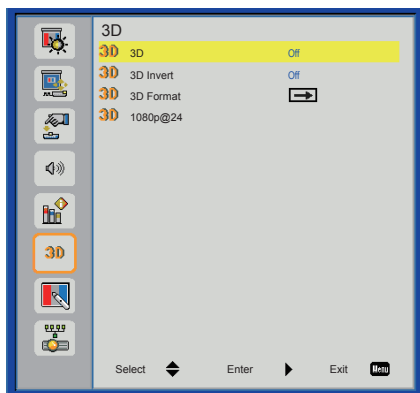

### 3D

- ▶ Auto: When a HDMI1.4a 3D timing identification signal is detected, the 3D image is selected automatically.
- ▶ Choose “Off” to disable 3D function.
- ▶ Choose “On” to enable 3D function.



- *The 3D display performance will depend on the 3D glasses you applied.*
- *If the input signal is analog, the projector can not automatically identification signal to manually switch to the “on”.*
- *When “3D” is enabled, “Color Mode”, “Digital Zoom”, “Color Temp.”, “Dynamic Black” and “Interactive” functions are not supported.*

### 3D Invert

If you see a discrete or overlapping image while wearing DLP 3D glasses, you may need to execute “Invert” to get best match of left/right image sequence to get the correct image.

### 3D Format

Use this feature to select the 3D format. Options are: “Frame Packing”, “Side-by-Side (Half)”, “Top and Bottom”, “Frame Sequential” and “Field Sequential”.



- *“Frame Sequential” is supported the DLP Link 3D input signals from VGA / HDMI connector.*
- *“Frame Sequential” / “Field Sequential” are supported the HQFS 3D input signals from Composite/S-video connector.*
- *“Frame Packing” / “Side-by-Side(Half)” / “Top and Bottom” are supported from HDMI 1.4a 3D input signals.*

### 1080p @24

Use this feature to select 96 or 144Hz refresh rate as using 3D glasses in the 1080p @ 24 frame packing.

# Interactive

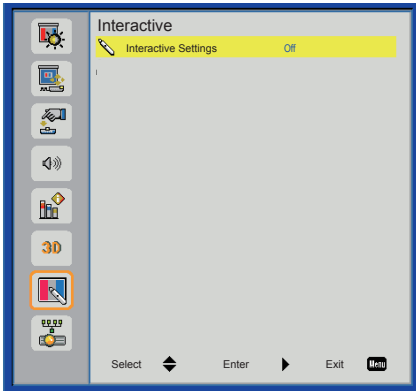

- NOTE**
- The Interactive function is available when displaying graphic source from HDMI/VGA input. Other sources are not supported.
  - If "3D" function is enabling, "Interactive" feature is disabling.

## Interactive Settings

Use this feature to select the Interactive Pen function. Options are: "Off" and "IR Camera". Choose "Off" to disable the Interactive Pen function.

You need to unplug the Mini USB cable that connects NB/desktop with the projector before using the Interactive function. After you complete the Interactive Settings in OSD, use Mini USB cable to connect NB/desktop with the projector.

The IR camera Interactive function needs an external IR camera. Please refer to below figure and plug in IR camera to projector before projector was installed.

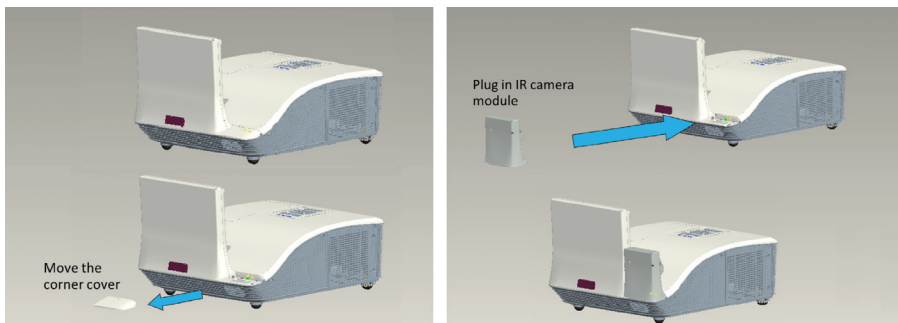

# LAN

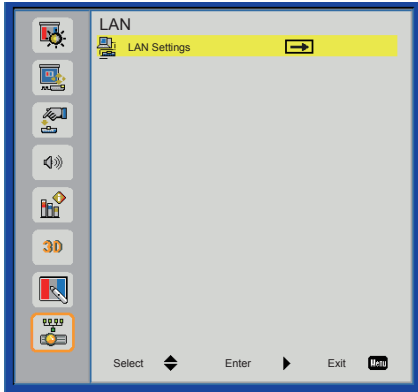

## LAN Settings

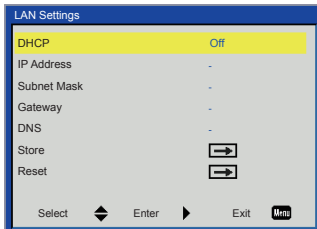

- ▶ DHCP: If a DHCP server exists in the network to which the projector is connected, the IP address will automatically be acquired when you select DHCP On. If DHCP is Off, manually set the IP Address, Subnet Mask, and Gateway. Use ▲ or ▼ to select the number of IP address, Subnet Mask, and Gateway.
- ▶ IP Address: Select an IP address.
- ▶ Subnet Mask: Configure the Subnet Mask of the LAN connection.
- ▶ Gateway: Check the Gateway address with your network/system administrator if you configure it manually.
- ▶ DNS: Check the DNS Server IP address with your network/system administrator if you configure it manually.
- ▶ Store: Choose “Yes” to save the changes made in network configuration settings.
- ▶ Reset: Choose “Yes” to return the display parameters on all menus to the factory default settings.



# Timer

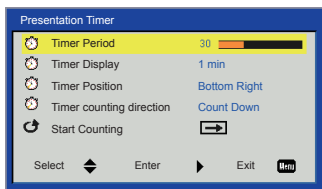

## Timer Period

Select timer period from 1 to 240 min.

## Timer Display

Select timer display from 1 min, 2 min, 3 min, Never or Always.

## Timer Position

Select timer position from Top Left, Top Right, Bottom Left or Bottom Right.

## Timer Counting Direction

Set the count down or count up timer interval.

## Start Counting

Turn on/off the Presentation timer.

## Web Management

1. Turn on DHCP to allow a DHCP server to automatically assign an IP, or manually enter the required network information.

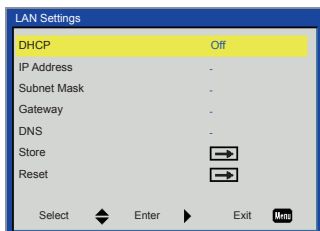

2. Open your web browser and type in IP Address from the OSD LAN.
3. Based on network web-page for the input-string in [tools] tab, the limitation for Input-Length is in the below list (“space” and the other punctuation key included):

Category	Item	Input-Length (characters)
Projector	Projector Name	21
	Location	21
	Administrator	21
Admin Password	New Password	4
	Confirm	4



- Use Internet Explorer 5.0 and above or Firefox 1.5 and above and enter the IP address. You can now access Web Management and manage the projector from a remote location.

## When making a direct connection from your computer to the projector

Step 1: Find an IP Address (192.168.10.100) from LAN function of projector.

Step 2: To open Network Connections, click **Start**, click **Control Panel**, click **Network and Internet Connections**, and then click **Network Connections**. Click the connection you want to configure, and then, under **Network Tasks**, click **Change settings of this connection**.

Step 3: On the **General** tab, under **This connection uses the following items**, click **Internet Protocol (TCP/IP)**, and then click "Properties."

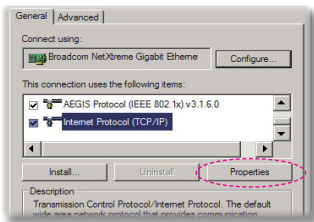

Step 4: Click **Use the following IP address**, and type in as below:

- ▶ IP address: 192.168.10.100
- ▶ Subnet mask: 255.255.255.0

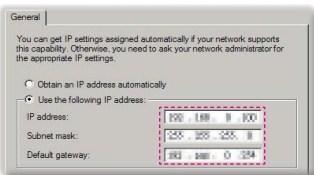

Step 5: To open Internet Options, click IE web browser, click Internet Options, click the **Connections** tab and click "LAN Settings..."

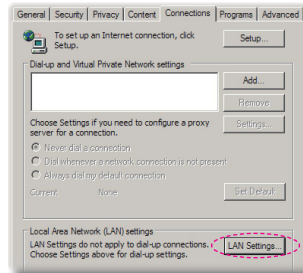

Step 6: The **Local Area Network (LAN) Setting** dialog box appears, In the **Proxy Server** area, cancel the **Use a proxy server for your LAN** check box., then click "OK" button twice.

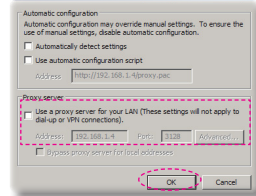

Step 7: Open your IE and type in the IP address of 192.168.10.100 in the URL then press "Enter" key.

## Projector Information Page

The screenshot shows the 'Web Management' interface with the 'Projector Information' page selected. The left sidebar contains navigation links: Projector Information (selected), LAN Setting, Projector Status and Control, E-mail Setting, Security Setting, and Firmware Update. The main content area displays the following information:

Model Name:	PJ08653w
Projector Name:	D21211
Location:	
Administrator:	
Status:	Lamp ON
Lamp Hours:	1 hr
Operation Hours:	2hr
IP Address:	192.168.0.100
MAC Address:	00:60:E9:28:52:D8
Admin Password:	Not Set

Below the table, there is a 'Language' section with a dropdown menu set to 'English' and a 'Submit' button.

- ▶ Projector Information page by entering the projector's IP address at the web browser. See "LAN Settings" section.
- ▶ Language: Allows you to set the language for web management.

## LAN Settings Page

The screenshot shows the 'Web Management' interface with the 'LAN Settings' page selected. The left sidebar contains navigation links: Projector Information, LAN Setting (selected), Projector Status and Control, E-mail Setting, Security Setting, and Firmware Update. The main content area displays the following settings:

Model Name:

Projector Name:

Location:

Administrator:

DHCP:  Manual

IP Address:

Subnet Mask:

Gateway:

DNS Server:

Crestron Control System Device

IP Address:

Device ID:

Port:

- ▶ Set up the Projector Name, Location and Administrator information (up to 21 characters for each field). Press Save to store the settings.
- ▶ Choose DHCP to assign an IP address to the projector from a DHCP server automatically, or Manual to assign an IP address manually.
- ▶ Set up the IP Address, Device ID and Port information on the Crestron function.

# Projector Status and Control Page

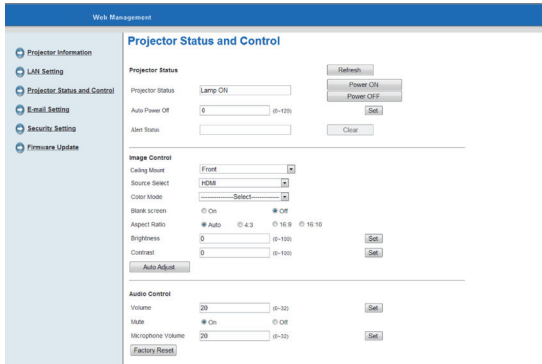

- ▶ **Projector Status:** There are 4 status: Standby, Warning up, Lamp On, Power Saving and Cooling. Click the Refresh button to refresh the status and control settings.
- ▶ **Auto Power Off:** Auto Power Off can be set to Off(0) or 1~120 minutes. See “Auto Power Off (min)” function.
- ▶ **Alert Status:** There are three error status: Lamp warning, Low lamp life, and Temperature warning. Your projector might lock up in protection mode if any of the alerts is activated. To exit protection mode, click the Clear to clear the Alert Status before you could Power ON your projector.
- ▶ **Ceiling Mount:** Allows you to select the projector mode, depending on how the projector is mounted. There are four projection modes: Front, Front Ceiling, Rear and Rear Ceiling. See “Ceiling Mount” function.
- ▶ **Source Select:** The Source Select menu allows you to select your projector's input source. You can select VGA-A, VGA-B, S-Video, Composite Video and HDMI.
- ▶ **Color Mode:** Select a mode to optimize the display image based on how the projector is being used. See “Color Mode” function.
- ▶ **Blank Screen:** Select On/Off to hide/unhide the screen picture.
- ▶ **Aspect Ratio:** Allows you to select the aspect ratio to adjust how the image appears.
- ▶ **Brightness:** Select value to adjust the brightness of the image.
- ▶ **Contrast:** Select value to adjust the display contrast.
- ▶ **Volume:** Select the value (0~32) for the audio volume
- ▶ **Mute:** Choose “On” to turn mute on. Choose “Off” to turn mute off.
- ▶ **Microphone Volume:** Select the value (0~32) for the Microphone Volume.



- Click the Auto Adjust button to adjust the settings automatically.
- Click the Factory Reset button to restore the factory default settings.

## E-mail Setting Page

The screenshot shows the 'E-mail Setting' page within a 'Web Management' interface. On the left is a navigation menu with options: Projector Information, LAN Setting, Projector Status and Control, E-mail Setting (selected), Security Setting, and Firmware Update. The main content area is titled 'E-mail Setting' and contains the following fields and options:

- E-mail Alert:** Radio buttons for 'Enable' and 'Disable' (selected), with a '+ E-mail Alert Text' button.
- TO:** Text input field.
- CC:** Text input field.
- From:** Text input field.
- Subject:** Text input field.
- SMTP Setting:**
  - Out going SMTP server: Text input field.
  - User name: Text input field.
  - Password: Text input field.
- Alert Condition:** Checkboxes for 'Lamp warning', 'Lamp life reminder', and 'Temperature warning'.
- Save:** A button at the bottom.

- ▶ E-mail Alert: You can set whether to be notified by email (Enable) or not (Disable).
- ▶ To/Cc/From: You can enter email address of sender (From) and recipients (To/ Cc) to receive notification when an abnormality or warning occurs.
- ▶ Out going SMTP server, User name, and Password should be provided by your network administrator or MIS.
- ▶ Alert Condition: You can select the abnormalities or warnings to be notified by email. When any of the alert conditions occur, an email will be sent to the recipients (To/Cc).



■ Click the Save button to the save settings.

## Security Setting Page

The screenshot shows the 'Security Setting' page within a 'Web Management' interface. On the left is a navigation menu with options: Projector Information, LAN Setting, Projector Status and Control, E-mail Setting, Security Setting (selected), and Firmware Update. The main content area is titled 'Security Setting' and contains the following elements:

- A message: "Please set your password if you enable this feature for first-time. If password is set, you will require to enter with your password upon you connect to the Web Management."
- Administrator:** Radio buttons for 'Enable' and 'Disable' (selected), with a 'Submit' button.
- New Password:** Text input field.
- Confirm Password:** Text input field, with a 'Submit' button.

- ▶ Password: Set up an administrator password to access the Web Management. When enabling password for the first time, set the password before enabling it. When the password function is enabled, the administrator password will be required for accessing the Web Management.
- ▶ New Password: Enter new password.
- ▶ Confirm Password: Enter password again and submit.



■ Contact Service Center if you forget your administrator password.

## Login Page

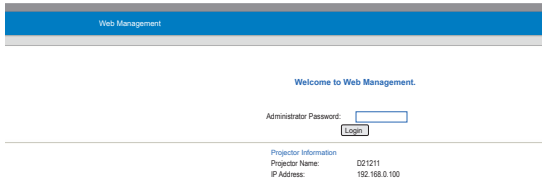

- ▶ Administrator Password: Enter the Administrator Password and click Login button.

## Firmware Update Page

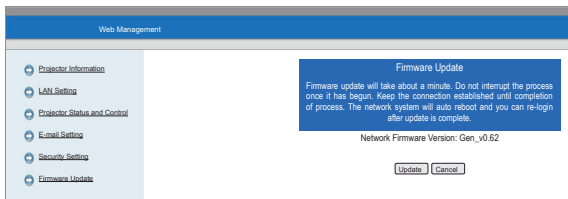

- ▶ Use the Firmware Update page to update your projector's firmware. Press Update button to start.

1. Please wait till the count reaches 0.

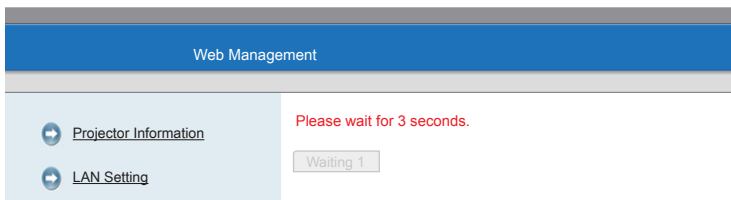

2. Wait for 3 seconds and it will proceed to the next step automatically.

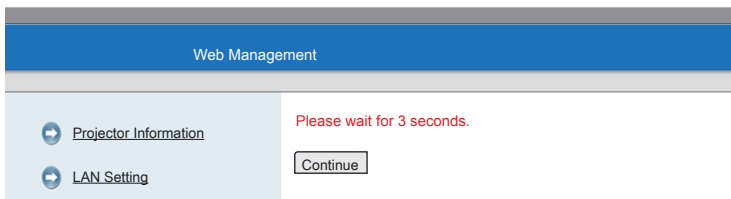

3. Select the file to upgrade and click the Upgrade button. When upgrading is in progress, the Cancel button is disabled.

**Upgrade Firmware**

Please select a file (~.bin) to upgrade:

(Upgrading firmware may take 60 seconds)

Upgrade must NOT be interrupted !

4. When upgrade is complete, please click the Re Login button to go back to the Web Management page.

Please wait.  
Click on button to proceed after 8 seconds.

## Crestron

- ▶ For more information, please visit <http://www.crestron.com> & [www.crestron.com/getroomview/](http://www.crestron.com/getroomview/)



# Appendices

## Troubleshooting

*If you experience a problem with your projector, please refer to the following information. If a problem persists, please contact your local reseller or service center.*

### Image Problems

#### **? No image appears on-screen**

- ▶ Ensure all the cables and power connections are correctly and securely connected as described in the “Installation” section.
- ▶ Ensure the pins of connectors are not crooked or broken.
- ▶ Check if the projection lamp has been securely installed.
- ▶ Ensure that the “Blank” feature is not turned on.

#### **? Partial, scrolling or incorrectly displayed image**

- ▶ Press “Auto Sync” on the remote control.
  - If you are using a PC:
    - For Windows 95, 98, 2000, XP, Windows 7:
      1. Open the “My Computer” icon, the “Control Panel” folder, and then double click on the “Display” icon.
      2. Select the “Settings” tab.
      3. Verify that your display resolution setting is lower than or equal to 1080p.
      4. Click on the “Advanced Properties”.
    - For Windows Vista:
      1. From the “My Computer” icon, open the “Control Panel” folder, and double click the “Appearance and Personalization”
      2. Select “Personalization”.
      3. Click “Adjust screen resolution” to display “Display Settings”. Click on the “Advanced Settings”.

- If the projector is still not projecting the whole image, you will also need to change the monitor display you are using. Refer to the following steps.
  1. Select the “Change” under the “Monitor” tab.
  2. Click on “Show all devices”. Next, select “Standard monitor types” under the SP box; choose the resolution mode you need under the “Models” box.
  3. Verify that the resolution setting of the monitor display is lower than or equal to 1080p.
- If you are using a Notebook:
  - First, follow the steps above to adjust resolution of the computer.
  - Press the toggle output settings. example: [Fn]+[F4]

Notebook Brand	Function Keys
Acer	[Fn]+[F5]
Asus	[Fn]+[F8]
Dell	[Fn]+[F8]
Gateway	[Fn]+[F4]
IBM/Lenovo	[Fn]+[F7]
HP/Compaq	[Fn]+[F4]
NEC	[Fn]+[F3]
Toshiba	[Fn]+[F5]
Mac Apple	System Preference -> Display -> Arrangement -> Mirror display

- If you experience difficulty changing resolutions or your monitor freezes, restart all equipment including the projector.

### **? The screen of the Notebook or PowerBook computer is not displaying your presentation**

Some Notebook PCs may deactivate their own screens when a second display device is in use. Each has a different way to be reactivated. Refer to your computer’s documentation for detailed information.

### **? Image is unstable or flickering**

- ▶ Adjust the “Phase” to correct it. Refer to the “Screen” section for more information.
- ▶ Change the monitor color setting from your computer.

### ? **Image has vertical flickering bar**

- ▶ Use “Clock” to make an adjustment. Refer to the “Screen” section for more information.
- ▶ Check and reconfigure the display mode of your graphic card to make it compatible with the product.

### ? **Image is out of focus**

- ▶ Adjust the “Focus Ring” on the projector lens.
- ▶ Make sure the projection screen is within the required distance. Refer to Pages 17-18.

### ? **The image is stretched when displaying 16:9 DVD title**

When you play anamorphic DVD or 16:9 DVD, the projector will show the best image in 16: 9 format on projector side.

- ▶ If you play 4:3 format DVD title, please change the format as 4:3 in projector OSD.
- ▶ If the image is still stretched, you will also need to setup the display format as 16:9 (wide) aspect ratio type on your DVD player.

### ? **Image is too small or too large**

- ▶ Move the projector closer to or further from the screen.
- ▶ Press “Menu” on the remote control or on the control panel. Go to “Screen” --> “Aspect Ratio” and try the different settings.

### ? **Image has slanted sides:**

- ▶ If possible, reposition the projector so that it is centered on the screen and below the Bottom of the screen.
- ▶ Use “Screen” --> “V Keystone” from the OSD to make an adjustment.

### ? **Image is reversed**

- ▶ Select “Screen” --> “Ceiling Mount” from the OSD and adjust the projection direction.

## Projector Problems

### ? The projector stops responding to all controls

- ▶ If possible, turn off the projector, then unplug the power cord and wait at least 20 seconds before reconnecting power.

### ? Lamp burns out or makes a popping sound

- ▶ When the lamp reaches its end of life, it will burn out and may make a loud popping sound. If this happens, the projector will not turn on until the lamp module has been replaced. To replace the lamp, follow the procedures in the “Replacing the Lamp” section on pages 59-60.

## Remote Control Problems

### ? If the remote control does not work

- ▶ Check the operating angle of the remote control is within  $\pm 35^\circ$  both horizontally and vertically of one of the IR receivers on the projector.
- ▶ Make sure there are not any obstructions between the remote control and the projector. Move to within 8 m ( $\pm 0^\circ$ ) of the projector.
- ▶ Make sure the batteries are inserted correctly.
- ▶ Replace batteries if they are exhausted.

## Sound Problems

### ? If no sound from the projector

- ▶ If you are playing an external source, make sure you have an audio cable securely connected between the source device and the projector's audio input.
- ▶ Please make sure the external speakers are not connected.
- ▶ Make sure the volume is not set to minimum.
- ▶ Make sure the “Volume --> Mute” function is set to “Off”.

## 3D Problems

### ? Blurry double image

- ▶ Select “3D” --> “3D” from OSD and choose “Off” to avoid normal 2D image is blurry double image.

## ? Two images, side-by-side format

- ▶ Select “3D” --> “3D Format” from OSD and choose “Side-by-Side(Half)” for input signal is HDMI 1.4a 3D. 3D Format is only supported on 3D Timing on page 58.

## ? Image does not display in 3D

- ▶ Check if the battery of 3D glasses is drained.
- ▶ Check if the 3D glasses is turned on.
- ▶ Select “3D” --> “3D Format” from OSD and choose “Side-by-Side(Half)” for input signal is HDMI 1.4a 3D. 3D Format is only supported on 3D Timing on page 58.

## On Screen Messages

- Power off confirm

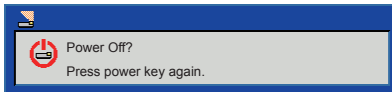

- Fan lock error

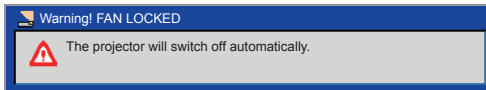

- No source found

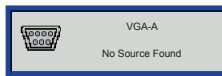

- Out of display range



- Over temperature



# Compatibility Modes

- VGA Analog
  - PC signal

Modes	Resolution	V. Frequency [Hz]	H. Frequency [Hz]
VGA	640x480	60	31.5
	640x480	67	35.0
	640x480	72	37.9
	640x480	75	37.5
	640x480	85	43.3
	640x480	120	61.9
IBM	720x400	70	31.5
SVGA	800x600	56	35.1
	800x600	60	37.9
	800x600	72	48.1
	800x600	75	46.9
	800x600	85	53.7
	800x600	120	77.4
Apple, MAC II	832x624	75	49.1
XGA	1024x768	60	48.4
	1024x768	70	56.5
	1024x768	75	60.0
	1024x768	85	68.7
	1024x768	120	99.0
Apple, MAC II	1152x870	75	68.7
SXGA	1280x1024	60	64.0
	1280x1024	72	77.0
	1280x1024	75	80.0
QuadVGA	1280x960	60	60.0
	1280x960	75	75.2
SXGA+	1400x1050	60	65.3
UXGA	1600x1200	60	75.0

- Extended wide timing

Modes	Resolution	V. Frequency [Hz]	H. Frequency [Hz]
WXGA	1280x720	60	44.8
	1280x800	60	49.6
	1366x768	60	47.7
	1440x900	60	59.9
WSXGA+	1680x1050	60	65.3

- Component signal

Modes	Resolution	V. Frequency [Hz]	H. Frequency [Hz]
480i	720x480(1440x480)	59.94(29.97)	15.7
576i	720x576(1440x576)	50(25)	15.6
480p	720x480	59.94	31.5
576p	720x576	50	31.3
720p	1280x720	60	45.0
720p	1280x720	50	37.5
1080i	1920x1080	60(30)	33.8
1080i	1920x1080	50(25)	28.1
1080p	1920x1080	23.98/24	27.0
1080p	1920x1080	60	67.5
1080p	1920x1080	50	56.3

- HDMI Digital
  - PC signal

Modes	Resolution	V. Frequency [Hz]	H. Frequency [Hz]
VGA	640x480	60	31.5
	640x480	67	35.0
	640x480	72	37.9
	640x480	75	37.5
	640x480	85	43.3
	640x480	120	61.9
IBM	720x400	70	31.5
SVGA	800x600	56	35.1
	800x600	60	37.9
	800x600	72	48.1
	800x600	75	46.9
	800x600	85	53.7
	800x600	120	77.4
Apple, MAC II	832x624	75	49.1
XGA	1024x768	60	48.4
	1024x768	70	56.5
	1024x768	75	60.0
	1024x768	85	68.7
	1024x768	120	99.0
Apple, MAC II	1152x870	75	68.7
SXGA	1280x1024	60	64.0
	1280x1024	72	77.0
	1280x1024	75	80.0
QuadVGA	1280x960	60	60.0
	1280x960	75	75.2
SXGA+	1400x1050	60	65.3
UXGA	1600x1200	60	75.0



- Extended wide timing

Modes	Resolution	V. Frequency [Hz]	H. Frequency [Hz]
WXGA	1280x720	60	44.8
	1280x800	60	49.6
	1366x768	60	47.7
	1440x900	60	59.9
WSXGA+	1680x1050	60	65.3

- Video signal

Modes	Resolution	V. Frequency [Hz]	H. Frequency [Hz]
480p	640x480	59.94/60	31.5
480i	720x480(1440x480)	59.94(29.97)	15.7
576i	720x576(1440x576)	50(25)	15.6
480p	720x480	59.94	31.5
576p	720x576	50	31.3
720p	1280x720	60	45.0
720p	1280x720	50	37.5
1080i	1920x1080	60(30)	33.8
1080i	1920x1080	50(25)	28.1
1080p	1920x1080	23.98/24	27.0
1080p	1920x1080	60	67.5
1080p	1920x1080	50	56.3

- HDMI 1.4a mandatory 3D timing- Video Signal

Modes	Resolution	V. Frequency [Hz]	H. Frequency [Hz]
Frame Packing	720p	50	31.5
	720p	59.94/60	15.7
	1080p	23.98/24	15.6
Side-by-Side(Half)	1080i	50	31.5
	1080i	59.94/60	31.3
Top and Bottom	720p	50	45.0
	720p	59.94/60	37.5
	1080p	23.98/24	33.8

# Replacing the lamp

The projector automatically detects the lamp life. When the lamp life is nearing the end of use, you will receive a warning message.

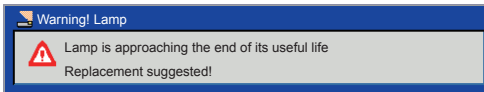

When you see this message, please contact your local reseller or service center to change the lamp as soon as possible. Make sure the projector has been cooled down for at least 60 minutes before changing the lamp.

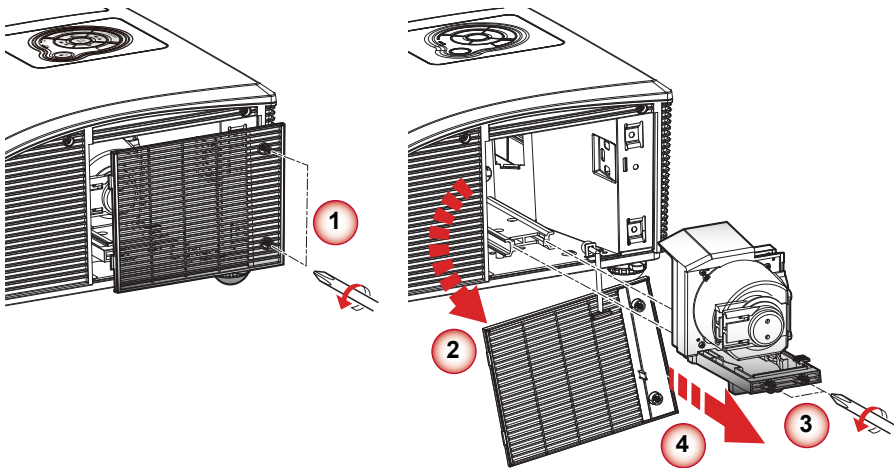

- The screws on the lamp cover and the lamp cannot be removed.
- The projector cannot be turned on if the lamp cover has not been placed back on the projector.
- Do not touch the glass area of the lamp. Hand oil can cause the lamp to shatter. Use a dry cloth to clean the lamp module if it was accidentally touched.

## Lamp Replacement Procedure:

1. Switch off the projector power by pressing the “**⏻**” button.
2. Allow the projector to cool down for at least 60 minutes.
3. Disconnect the power cord.
4. Unscrew the two screws on the cover. ①
5. Lift up and remove the cover. ②
6. Unscrew the two screws on the lamp module. ③
7. Pull up the lamp handle and remove the lamp module slowly and carefully. ④
8. To replace the lamp module, reverse the previous steps.
9. Turn on the projector and use “Lamp Reset” after the lamp module is replaced.

# Replacing and cleaning the optional dust filter

We recommend cleaning the dust filter after every 500 hours of use, clean it more often if the projector is used in a dusty environment.

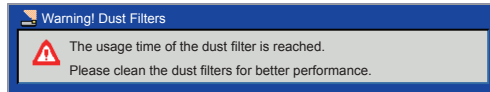

When you see this message, please find following steps for cleaning procedure:

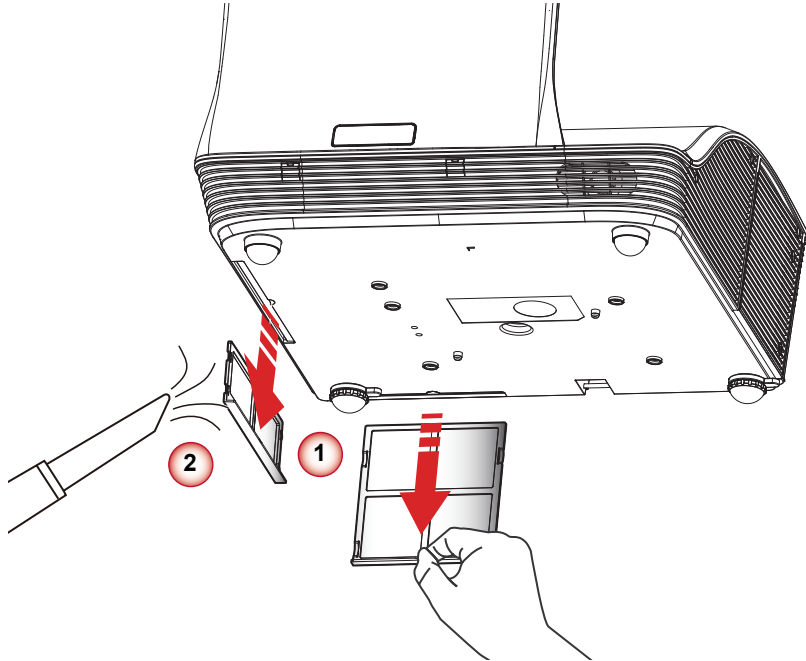

NOTE

- The optional dust filter should be used in dusty environments.
- If the dust filter is installed, proper maintenance will prevent overheating and related damage to the projector.

## Cleaning the Dust Filter Procedure:

1. Switch off the projector power by pressing the “**⏻**” button.
2. Disconnect the power cord.
3. Pull the latch by the arrow direction. (1)
4. Remove the dust filter slowly and carefully.
5. Clean or replace the dust filter. (2)
6. To install the dust filter, reverse the previous steps.
7. Turn on the projector and use “Reset Dust Filter” after the dust filter is replaced.

# Ceiling Mount Installation

If you wish to use a third party ceiling mount kit, please ensure the screws which are used to attach a mount to the projector meet the following specifications:

- Screw type: M4x4
  - Diameter: 4 mm
  - Length: 11 mm



■ Please note that damage resulting from incorrect installation will invalidate the warranty.

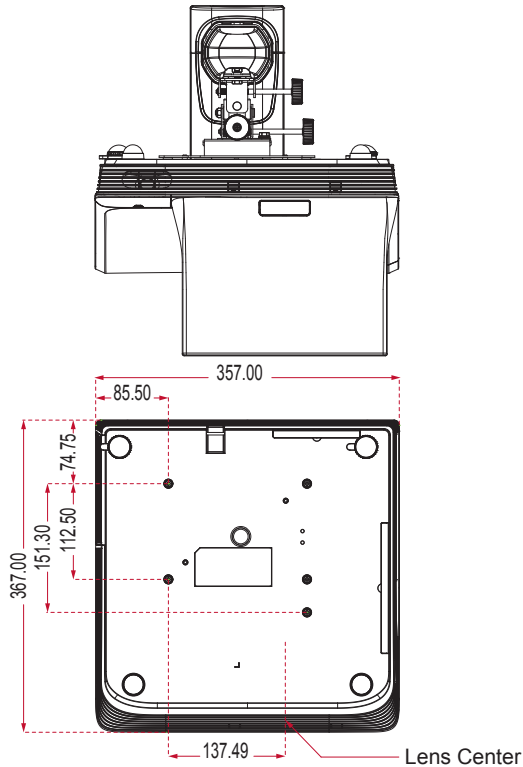

Unit: mm

# Specifications

Model Name	PJD8653ws	PJD8353s
Projection system	DLP®	
Resolution	WXGA (1280x800)	XGA (1024x768)
Computer compatibility	IBM PC and compatibles, Apple Macintosh, iMac and VESA standards: SXGA, XGA, SVGA, VGA, WXGA, UXGA	
Video compatibility	NTSC (3.58/4.43), PAL (B/D/G/H/I/M/N), SECAM (B/D/G/ K/ K1/L), HDTV (720p, 1080i, 1080p), SDTV (480i, 480p, 576i, 576p)	
Aspect ratio	Auto, 4:3, 16:9, 16:10	
Displayable colors	1.07 billion colors	
Projection lens	F# 2.6	
Projection screen size	80.2" - 96.6" (Diagonal)	68" - 81.9" (Diagonal)
Max. focus screen size	70" - 100" (Diagonal)	60" - 90" (Diagonal)
Projection distance	517 mm - 759 mm (±10mm)	522 mm - 802 mm (±10mm)
Throw ratio	0.35	0.43
Horizontal scan rate	30 k - 100 kHz	
Vertical refresh scan rate	50 - 120 Hz	
Keystone correction	±15 degrees	
Weight	7.5 Kg (16.5 lbs)	
Dimensions (W x D x H)	357 (W) x 367 (D) x 135(H) mm (excluding foot) 357 (W) x 367 (D) x 231(H) mm (including reflection mirror)	
Power supply	AC 100 - 240 V, 50 - 60 Hz	
Power consumption	<ul style="list-style-type: none"> <li>• Normal mode: 300W ±10% @ 110Vac (Bright mode @ full power)</li> <li>• ECO mode: 240W ±10% @ 110Vac (Video mode @ eco power)</li> <li>• Standby &lt; 0.5 W</li> </ul>	
Operating temperature	5°C to 40°C / 41°F to 104°F	

#### I/O connectors

- Power socket x 1
- LAN (RJ45) x 1
- RS232 x 1
- DC12V x 1
- HDMI x 1
- VGA input x 2
- VGA output x 1
- S-Video x 1
- Composite x 1
- 3.5 mm audio jack input x 2
- RCA (L/R) audio jack input x 2
- 3.5 mm audio jack input (Microphone)x 1
- 3.5 mm audio jack input x 1
- Mini USB B x 1

#### Standard package contents

- AC power cord x 1
- VGA cable x 1
- Remote control x 1
- AAA x 2
- User's guide (DVD) x 1
- Quick start card x 1



- *Design and specifications are subject to change without prior notice.*

# Customer Support

For technical support or product service, see the table below or contact your reseller.

**Note :** You will need the product serial number.

Country/Region	Website	T = Telephone F = FAX	Email
Australia/New Zealand	www.viewsonic.com.au	AUS= 1800 880 818 NZ= 0800 008 822	service@au.viewsonic.com
Canada	www.viewsonic.com	T (Toll-Free)= 1-866-463-4775 T (Toll)= 1-424-233-2533 F= 1-909-468-3757	service.ca@viewsonic.com
Europe	www.viewsoniceurope.com	www.viewsoniceurope.com/uk/support/call-desk/	
Hong Kong	www.hk.viewsonic.com	T= 852 3102 2900	service@hk.viewsonic.com
India	www.in.viewsonic.com	T= 1800 266 0101	service@in.viewsonic.com
Korea	www.kr.viewsonic.com	T= 080 333 2131	service@kr.viewsonic.com
Latin America (Argentina)	www.viewsonic.com/la/	T= 0800-4441185	soporte@viewsonic.com
Latin America (Chile)	www.viewsonic.com/la/	T= 1230-020-7975	soporte@viewsonic.com
Latin America (Columbia)	www.viewsonic.com/la/	T= 01800-9-157235	soporte@viewsonic.com
Latin America (Mexico)	www.viewsonic.com/la/	T= 001-8882328722	soporte@viewsonic.com
Renta y Datos, 29 SUR 721, COL. LA PAZ, 72160 PUEBLA, PUE. Tel: 01.222.891.55.77 CON 10 LINEAS Electroses, Av Reforma No. 403Gx39 y 41, 97000 Mérida, Yucatán. Tel: 01.999.925.19.16 Other places please refer to <a href="http://www.viewsonic.com/la/soporte/index.htm#Mexico">http://www.viewsonic.com/la/soporte/index.htm#Mexico</a>			
Latin America (Peru)	www.viewsonic.com/la/	T= 0800-54565	soporte@viewsonic.com
Macau	www.hk.viewsonic.com	T= 853 2870 0303	service@hk.viewsonic.com
Middle East	ap.viewsonic.com/me/	Contact your reseller	service@ap.viewsonic.com
Puerto Rico & Virgin Islands	www.viewsonic.com	T= 1-800-688-6688 (English) T= 1-866-379-1304 (Spanish) F= 1-909-468-3757	service.us@viewsonic.com soporte@viewsonic.com
Singapore/Malaysia/Thailand	www.viewsonic.com.sg	T= 65 6461 6044	service@sg.viewsonic.com
South Africa	ap.viewsonic.com/za/	Contact your reseller	service@ap.viewsonic.com
United States	www.viewsonic.com	T (Toll-Free)= 1-800-688-6688 T (Toll)= 1-424-233-2530 F= 1-909-468-3757	service.us@viewsonic.com

# Limited Warranty

## ViewSonic® Projector

### What the warranty covers:

ViewSonic warrants its products to be free from defects in material and workmanship, under normal use, during the warranty period. If a product proves to be defective in material or workmanship during the warranty period, ViewSonic will, at its sole option, repair or replace the product with a like product. Replacement product or parts may include remanufactured or refurbished parts or components.

### Limited Three (3) year General Warranty

Subject to the more limited one (1) year warranty set out below, North and South America: Three (3) years warranty for all parts excluding the lamp, three (3) years for labor, and one (1) year for the original lamp from the date of the first consumer purchase.

Other regions or countries: Please check with your local dealer or local ViewSonic office for the warranty information.

### Limited One (1) year Heavy Usage Warranty:

Under heavy usage settings, where a projector's use includes more than fourteen (14) hours average daily usage, North and South America: One (1) year warranty for all parts excluding the lamp, one (1) year for labor, and ninety (90) days for the original lamp from the date of the first consumer purchase; Europe: One (1) year warranty for all parts excluding the lamp, one (1) year for labor, and ninety (90) days for the original lamp from the date of the first consumer purchase.

Other regions or countries: Please check with your local dealer or local ViewSonic office for the warranty information.

Lamp warranty subject to terms and conditions, verification and approval. Applies to manufacturer's installed lamp only. All accessory lamps purchased separately are warranted for 90 days.

### Who the warranty protects:

This warranty is valid only for the first consumer purchaser.

### What the warranty does not cover:

1. Any product on which the serial number has been defaced, modified or removed.
2. Damage, deterioration, failure, or malfunction resulting from:
  - a. Accident, abuse, misuse, neglect, fire, water, lightning, or other acts of nature, improper maintenance, unauthorized product modification, or failure to follow instructions supplied with the product.
  - b. Operation outside of product specifications.
  - c. Operation of the product for other than the normal intended use or not under normal conditions.
  - d. Repair or attempted repair by anyone not authorized by ViewSonic.
  - e. Any damage of the product due to shipment.
  - f. Removal or installation of the product.
  - g. Causes external to the product, such as electric power fluctuations or failure.
  - h. Use of supplies or parts not meeting ViewSonic's specifications.
  - i. Normal wear and tear.
  - j. Any other cause which does not relate to a product defect.
3. Removal, installation, and set-up service charges.



**How to get service:**

1. For information about receiving service under warranty, contact ViewSonic Customer Support (please refer to “Customer Support” page). You will need to provide your product’s serial number.
2. To obtain warranted service, you will be required to provide (a) the original dated sales slip, (b) your name, (c) your address, (d) a description of the problem, and (e) the serial number of the product.
3. Take or ship the product freight prepaid in the original container to an authorized ViewSonic service center or ViewSonic.
4. For additional information or the name of the nearest ViewSonic service center, contact ViewSonic.

**Limitation of implied warranties:**

There are no warranties, express or implied, which extend beyond the description contained herein including the implied warranty of merchantability and fitness for a particular purpose.

**Exclusion of damages:**

ViewSonic’s liability is limited to the cost of repair or replacement of the product. ViewSonic shall not be liable for:

1. Damage to other property caused by any defects in the product, damages based upon inconvenience, loss of use of the product, loss of time, loss of profits, loss of business opportunity, loss of goodwill, interference with business relationships, or other commercial loss, even if advised of the possibility of such damages.
2. Any other damages, whether incidental, consequential or otherwise.
3. Any claim against the customer by any other party.

**Effect of local law:**

This warranty gives you specific legal rights, and you may also have other rights which vary from local authority. Some local governances do not allow limitations on implied warranties and/or do not allow the exclusion of incidental or consequential damages, so the above limitations and exclusions may not apply to you.

**Sales outside the U.S.A. and Canada:**

For warranty information and service on ViewSonic products sold outside of the U.S.A. and Canada, contact ViewSonic or your local ViewSonic dealer.

The warranty period for this product in mainland China (Hong Kong, Macao and Taiwan Excluded) is subject to the terms and conditions of the Maintenance Guarantee Card.

For users in Europe and Russia, full details of warranty provided can be found in [www.viewsoniceurope.com](http://www.viewsoniceurope.com) under Support/Warranty Information.

# Mexico Limited Warranty

## ViewSonic® Projector

### What the warranty covers:

ViewSonic warrants its products to be free from defects in material and workmanship, under normal use, during the warranty period. If a product proves to be defective in material or workmanship during the warranty period, ViewSonic will, at its sole option, repair or replace the product with a like product. Replacement product or parts may include remanufactured or refurbished parts or components & accessories.

### How long the warranty is effective:

3 years for all parts excluding the lamp, 3 years for labor, 1 year for the original lamp from the date of the first consumer purchase.

Lamp warranty subject to terms and conditions, verification and approval. Applies to manufacturer's installed lamp only.

All accessory lamps purchased separately are warranted for 90 days.

### Who the warranty protects:

This warranty is valid only for the first consumer purchaser.

### What the warranty does not cover:

1. Any product on which the serial number has been defaced, modified or removed.
2. Damage, deterioration or malfunction resulting from:
  - a. Accident, misuse, neglect, fire, water, lightning, or other acts of nature, unauthorized product modification, unauthorized attempted repair, or failure to follow instructions supplied with the product.
  - b. Any damage of the product due to shipment.
  - c. Causes external to the product, such as electrical power fluctuations or failure.
  - d. Use of supplies or parts not meeting ViewSonic's specifications.
  - e. Normal wear and tear.
  - f. Any other cause which does not relate to a product defect.
3. Any product exhibiting a condition commonly known as "image burn-in" which results when a static image is displayed on the product for an extended period of time.
4. Removal, installation, insurance, and set-up service charges.

### How to get service:

For information about receiving service under warranty, contact ViewSonic Customer Support (Please refer to the attached Customer Support page). You will need to provide your product's serial number, so please record the product information in the space provided below on your purchase for your future use. Please retain your receipt of proof of purchase to support your warranty claim.

For Your Records

Product Name: \_\_\_\_\_ Model Number: \_\_\_\_\_  
Document Number: \_\_\_\_\_ Serial Number: \_\_\_\_\_  
Purchase Date: \_\_\_\_\_ Extended Warranty Purchase? \_\_\_\_\_ (Y/N)  
If so, what date does warranty expire? \_\_\_\_\_

1. To obtain warranty service, you will be required to provide (a) the original dated sales slip, (b) your name, (c) your address, (d) a description of the problem, and (e) the serial number of the product.
2. Take or ship the product in the original container packaging to an authorized ViewSonic service center.
3. Round trip transportation costs for in-warranty products will be paid by ViewSonic.

### Limitation of implied warranties:

There are no warranties, express or implied, which extend beyond the description contained herein including the implied warranty of merchantability and fitness for a particular purpose.

### Exclusion of damages:

ViewSonic's liability is limited to the cost of repair or replacement of the product. ViewSonic shall not be liable for:

1. Damage to other property caused by any defects in the product, damages based upon inconvenience, loss of use of the product, loss of time, loss of profits, loss of business opportunity, loss of goodwill, interference with business relationships, or other commercial loss, even if advised of the possibility of such damages.
2. Any other damages, whether incidental, consequential or otherwise.
3. Any claim against the customer by any other party.
4. Repair or attempted repair by anyone not authorized by ViewSonic.

<b>Contact Information for Sales &amp; Authorized Service (Centro Autorizado de Servicio) within Mexico:</b>	
<b>Name, address, of manufacturer and importers:</b> México, Av. de la Palma #8 Piso 2 Despacho 203, Corporativo Interpalmas, Col. San Fernando Huixquilucan, Estado de México Tel: (55) 3605-1099 <a href="http://www.viewsonic.com/la/soporte/index.htm">http://www.viewsonic.com/la/soporte/index.htm</a>	
<b>NÚMERO GRATIS DE ASISTENCIA TÉCNICA PARA TODO MÉXICO: 001.866.823.2004</b>	
<b>Hermosillo:</b> Distribuciones y Servicios Computacionales SA de CV. Calle Juarez 284 local 2 Col. Bugambilias C.P: 83140 Tel: 01-66-22-14-9005 E-Mail: <a href="mailto:disc2@hmo.megared.net.mx">disc2@hmo.megared.net.mx</a>	<b>Villahermosa:</b> Compumantenimientos Garantizados, S.A. de C.V. AV. GREGORIO MENDEZ #1504 COL, FLORIDA C.P. 86040 Tel: 01 (993) 3 52 00 47 / 3522074 / 3 52 20 09 E-Mail: <a href="mailto:compumantenimientos@prodigy.net.mx">compumantenimientos@prodigy.net.mx</a>
<b>Puebla, Pue. (Matriz):</b> RENTA Y DATOS, S.A. DE C.V. Domicilio: 29 SUR 721 COL. LA PAZ 72160 PUEBLA, PUE. Tel: 01(52)222.891.55.77 CON 10 LINEAS E-Mail: <a href="mailto:datos@puebla.megared.net.mx">datos@puebla.megared.net.mx</a>	<b>Veracruz, Ver.:</b> CONEXION Y DESARROLLO, S.A DE C.V. Av. Americas # 419 ENTRE PINZÓN Y ALVARADO Fracc. Reforma C.P. 91919 Tel: 01-22-91-00-31-67 E-Mail: <a href="mailto:gacosta@qplus.com.mx">gacosta@qplus.com.mx</a>
<b>Chihuahua</b> Soluciones Globales en Computación C. Magisterio # 3321 Col. Magisterial Chihuahua, Chih. Tel: 4136954 E-Mail: <a href="mailto:Cefeo@soluglobales.com">Cefeo@soluglobales.com</a>	<b>Cuernavaca</b> Compusupport de Cuernavaca SA de CV Francisco Leyva # 178 Col. Miguel Hidalgo C.P. 62040, Cuernavaca Morelos Tel: 01 777 3180579 / 01 777 3124014 E-Mail: <a href="mailto:aquevedo@compusupportcva.com">aquevedo@compusupportcva.com</a>
<b>Distrito Federal:</b> QPLUS, S.A. de C.V. Av. Coyoacán 931 Col. Del Valle 03100, México, D.F. Tel: 01(52)55-00-20-27-35 E-Mail : <a href="mailto:gacosta@qplus.com.mx">gacosta@qplus.com.mx</a>	<b>Guadalajara, Jal.:</b> SERVICRECE, S.A. de C.V. Av. Niños Héroes # 2281 Col. Arcos Sur, Sector Juárez 44170, Guadalajara, Jalisco Tel: 01(52)33-36-15-15-43 E-Mail: <a href="mailto:mmiranda@servicrece.com">mmiranda@servicrece.com</a>
<b>Guerrero Acapulco</b> GS Computación (Grupo Sesiscomp) Progreso #6-A, Colo Centro 39300 Acapulco, Guerrero Tel: 744-48-32627	<b>Monterrey:</b> Global Product Services Mar Caribe # 1987, Esquina con Golfo Pérsico Fracc. Bernardo Reyes, CP 64280 Monterrey N.L. México Tel: 8129-5103 E-Mail: <a href="mailto:aydeem@gps1.com.mx">aydeem@gps1.com.mx</a>
<b>MÉRIDA:</b> ELECTROSER Av Reforma No. 403Gx39 y 41 Mérida, Yucatán, México CP97000 Tel: (52) 999-925-1916 E-Mail: <a href="mailto:rrb@sureste.com">rrb@sureste.com</a>	<b>Oaxaca, Oax.:</b> CENTRO DE DISTRIBUCION Y SERVICIO, S.A. de C.V. Murguía # 708 P.A., Col. Centro, 68000, Oaxaca Tel: 01(52)95-15-15-22-22 Fax: 01(52)95-15-13-67-00 E-Mail: <a href="mailto:gpotai2001@hotmail.com">gpotai2001@hotmail.com</a>
<b>Tijuana:</b> STD Av Ferrocarril Sonora #3780 L-C Col 20 de Noviembre Tijuana, Mexico	<b>FOR USA SUPPORT:</b> ViewSonic Corporation 381 Brea Canyon Road, Walnut, CA. 91789 USA Tel: 800-688-6688 (English); 866-323-8056 (Spanish); Fax: 1-800-685-7276 E-Mail: <a href="http://www.viewsonic.com">http://www.viewsonic.com</a>

Projector Mexico Warranty Term Template In UG

VSC\_TEMP\_2006



ViewSonic®